

XGC400-I Lattice Crawler Crane



XGC400-I

RONCO GROUP





CONTENTS

P02	<ul style="list-style-type: none">• PARTS AND SYSTEM DESCRIPTION OF THE CRANE• MAIN TECHNICAL PARAMETERS• LIFTING CAPACITY TABLE IN TYPICAL WORKING CONDITIONS
P46	<ul style="list-style-type: none">• TRANSPORT PLAN• SUPPLIED TOOLS• SUPPLIED SPARE PARTS• PACKING LIST

02

XGC400-I CRAWLER CRANE

P03-P07	PARTS AND SYSTEM DESCRIPTION OF THE CRANE
P08-P10	MAIN TECHNICAL PARAMETERS
P08-P08	LIFTING CAPACITY TABLE IN TYPICAL WORKING CONDITIONS
	<ol style="list-style-type: none">1. Standard heavy boom working condition (HB)2. Standard light boom working condition (LB)3. Standard tower jib working condition (HW)4. Standard goose head jib working condition (HJ)5. Standard fixed jib working condition (HF)6. Standard TBM working condition (HFS)7. Superlift heavy boom working condition (SHB)8. Superlift light boom working condition (SLB)9. Superlift tower jib working condition (SHW)10. Superlift goose head jib working condition (SHJ)11. Superlift TBM working condition (SHFS)

PARTS AND SYSTEM DESCRIPTION OF THE CRANE

Product component and system description

Boom combination

The boom sections of XGC400-I crawler crane use high-strength seamless pipe as the chords and lacing tubes, supplemented by four-chord lattice structure which is welded by high strength steel plate, with equal section in the middle and variable section at two ends.

1) Standard working condition

①HB: Standard heavy boom working condition, boom length 24~84m, composition: 10.5m boom butt × 1, 6m boom insert × 2, 12m thick-wall boom insert I × 1, 12m thick-wall boom insert II × 1, 12m thin-wall boom insert × 2, 6m transition section × 1, 6m light boom section × 1, 1.5m boom head × 1, boom head sheave block × 1.

②LB: Standard light boom working condition, length 42~108m, composition: 10.5m boom butt × 1, 6m boom insert × 1, 12m thick-wall boom insert I × 1, 12m thick-wall boom insert II × 1, 12m thin-wall boom insert × 2, 6m boom transition section × 1, 6m tower jib insert I × 1, 6m tower jib insert II × 1, 12m thick-wall tower jib insert × 1, 12m thin-wall tower jib insert × 1, 7.5m tower jib top × 1.

③HW: Heavy boom + tower jib, boom length 30~60m, tower jib length 24~72m, tower jib composition: 10.5m tower jib butt × 1, 6m tower jib insert I × 1, 6m tower jib insert II × 2, 12m thick-wall tower jib insert × 1, 12m thin-wall tower jib insert × 1, 12m tower jib center hitch section × 1, 7.5m tower jib top × 1.

④HF: Fixed jib working condition. Fixed jib can be installed when boom length is 24~78m. Fixed jib length is 9m.

⑤HJ: Heavy boom + goose head jib (optional configuration), goose head jib can be installed when boom length is 66m~84m. Goose head jib is composed of 0.8m connection section and 7m goose head jib top section.

⑥HFS: TBM jib (optional configuration), boom length 24m, jib length 9m.

2) Superlift working condition

①SHB: Superlift heavy boom working condition, 36 ~ 84m, heavy boom combination is the same as that in standard working condition. Customers can choose an additional 12m boom insert (option) to make the total boom length reach 96m.

②SLB: Superlift light boom working condition, 72 ~ 126m, composition: 10.5m boom butt × 1, 6m boom insert × 2, 12m thick-wall boom insert I × 1, 12m thick-wall boom insert II × 1, 12m thin-wall boom insert × 2, 6m transition section × 1, 6m tower jib insert I × 1, 6m tower jib insert II × 2, 12m thick-wall tower jib insert × 1, 12m thin-wall tower jib insert × 1, 7.5m tower jib top × 1.

③SHW: Superlift heavy boom + tower jib, heavy boom length 36~84m, tower jib length 24~84m, tower jib composition: 10.5m tower jib butt × 1, 6m tower jib insert I × 1, 6m tower jib insert II × 2, 12m thick-wall tower jib insert × 1, 12m thin-wall tower jib insert × 2, 12m tower jib center hitch section × 1, 7.5m tower jib top × 1.

Boom combination

④SHJ: Superlift heavy boom + goose head jib (optional configuration), goose head jib can be installed when boom length is 78m~96m. Goose head jib is composed of 0.8m connection section and 7m goose head jib top section.

⑤SHFS: Superlift TBM jib (optional configuration), boom length is 36m, and jib length is 9m.

Turntable

Turntable is a box frame structure and welded by high strength steel plate. The overall structure is a large box frame with equal strength, the I-shaped main vertical plates at left and right sides are connected with box beam. This structure is with strong bending and torsion resistance and good stability. At the same time, the space in turntable is large, which is convenient for crane maintenance. Turntable is connected to undercarriage through slewing bearing. Many important parts are installed on turntable, such as operator's cab, main luffing winch, main and aux. hoist winches, engine, mast, turntable counterweight and boom system.

Pendant

High strength pendant structure, it is composed of two groups of pendant. The pendant is made of high strength steel with high safety factor. The pendant is equipped with a balance beam, which can effectively balance the load on the two pendant groups, so that the force is uniform.

Mast

Standard mast is box-type structure of twin tubular chord, with good overall stability. The mast is equipped with mast raising mechanism and mast installation power pin. Auxiliary assembly cylinder is fitted to realize the self-assembly/disassembly function of track frame, center counterweight and boom. The mast can be transported with main luffing mechanism.

Superlift mast uses high strength seamless pipe as the chord and lacing members, supplemented by four-chord lattice structure which is welded by high strength steel plate, with equal section in the middle and variable section at two ends. The length of superlift mast is 30m, including one bottom section, one 6m section, one 12m section and one top section. The superlift mast is equipped with automatically controlled hydraulic backstop device.

Mechanism composition

See the following table for the configuration and use of the mechanisms of the crane.

1	Main hoist winch	Used for the lifting operation of boom, fixed jib and tower jib	Turntable
2	Aux. hoist winch	Used for the lifting operation of boom, fixed jib and tower jib	Turntable
3	Boom luffing winch	Used for boom luffing operation	Turntable
4	Tower jib luffing winch	Used for tower jib luffing operation	Boom butt
5	Superlift luffing winch	Used for superlift boom luffing operation	Superlift mast butt. section
6	Slewing gear	Used for superstructure slewing	Turntable
7	Travel gear	Used for crane travel	Crawler track
8	Reeving winch	Assist the reeving of wire rope	Turntable
9	Single top hoist winch	Used for single top lifting operation	Boom butt

Hoist winch

Main and aux. winches have the same model and driven independently. They can work synchronously for heavy load lifting. Hoist winches adopt constant-closed disc brake, built-in reducer and variable displacement drive motor. The two winches use box frame, hydraulic power pin is used to connect them to turntable. Single top hoist winch is used for single top lifting operation.

The wire ropes are all rotation resistance. For main hoist winch, rope diameter ϕ 28 mm; for aux. hoist winch, rope diameter ϕ 28 mm. Single top hoisting rope diameter is ϕ 26mm.

Luffing winch

Boom luffing winch is twin drum form. Ratchet lock device, built-in reducer and constant-closed disc brake are adopted for this system, rope diameter ϕ 26 mm.

Tower jib luffing winch adopts ratchet lock device, built-in reducer and constant-closed disc brake, rope diameter ϕ 26 mm.

Superlift luffing winch adopts ratchet lock device, built-in reducer and constant-closed disc brake, rope diameter ϕ 26 mm.

Slewing gear

Slewing gear is arranged in front of turntable, two planetary reducers are used to make it externally meshed with slewing bearing, with hydraulic buffering and free swing function. Constant-closed disc brake is used; it is reliable in work and easy for maintenance.

Slewing bearing

The three-row roller type slewing bearing are externally meshed, with features of high strength, large bearing torque and easy maintenance.

Oil cylinder assembly

The connection between boom and turntable, the connection between car-body and track frame, the installation of hoisting winches and the installation of main luffing mechanism are all realized by the use of hydraulic power pin. This crane is equipped with mast raising cylinder, mast derrick cylinder, car-body outrigger cylinder, track tension cylinder and etc., the operator's cab is also set with cab tilting cylinder and cab rotation cylinder.

Operator's cab

Operator's cab is steel frame structure. The front is equipped with integral laminated glass, while others are tempered glass. The cab is equipped with adjustable seat, all kinds of ergonomic designed instruments and controls, vent type air conditioner, stereo, fire extinguisher, and closed circuit monitoring system, spacious and comfortable.

When the crane is in operation, the cab can be tilted upward to widen the field of vision. When the crane is in transport, the cab can be turned to the front side to reduce the transport width.

Car-body

Car-body is made of high strength steel plate and welded in box type structure. Cross panel is set in the middle to strengthen its torsion stiffness, simple structure, high load bearing capacity and good rigidity.

Crawler travel device

Crawler track consists of crawler beam, drive sprocket, idler wheel, upper roller, lower roller and track shoe. Crawler beam is box-shape structure, its connection part with car-body is strengthened partially, and cross panel is installed in the middle of it. The rollers and track shoes are all made of high strength alloy cast steel.

The two track frames are set symmetrically, installed with crawler shoes of 1.2m in width. They can be operated synchronously or separately to realize straight travel and turning. Four-wheel-drive travel reducer, built-in planetary gear reducer and variable displacement motor drive.

PARTS AND SYSTEM DESCRIPTION OF THE CRANE

Hydraulic system

It adopts electric proportional pilot variable pump control system, with combination of open and closed circuit, the system is stable with good speed adjustment.

Hoist system, luffing system and travel system are all open pump control systems, main luffing system is with dual pump confluence function.

Slewing system is closed pump control system, with a special slewing buffer valve; the transmission is stable without impact.

For main hoist, aux. hoist and travel systems with large speed regulation range, variable motor drive is adopted. The combination of variable motor and variable pump control system can achieve accurate control of the movement speed, with good fine motion performance.

Electrical system

Electrical system mainly includes the following parts: engine control, monitoring instruments, auxiliary equipment, hydraulic system control, load moment limit and safety monitoring, etc.

Composition of electrical system: conventional electrical system and PLC control system.

The conventional electrical system adopts 24V parallel circuit, and the wiring of all electric equipments adopts single wire system, negative earth. It includes power supply, starting control, engine control and status monitoring, cab air conditioner and stereo, illumination (lighting), wipers, walkie talkies, etc.

The PLC control system includes the control of hoisting, luffing, slewing, travel and the rotation and tilting of operator's cab. All movements adopt electro-hydraulic proportional control technology and controlled through PLC logic, which can effectively guarantee the realization of all functions of the crane.

Engine system

Model: Weichai WP12.460N

Rated power: 338 kW/1900rpm

Max. torque/Max. torque speed: 2110Nm/1400rpm;

Type: Straight-line, six-cylinder, water-cooled, turbo charging intercooler, electronic fuel injection, four-stroke environmental friendly diesel engine;

Environmental protection property: meet EU III or China III emission standard;

Fuel tank capacity: 750L.

Counterweight

Counterweight system includes car-body counterweight, turntable counterweight and superlift counterweight.

Car-body counterweights are installed on track frame, its self-assembly/disassembly is realized through the use of mast derrick. Car-body counterweight is 40t in total, composition: car-body counterweight 2 × 20t.

Turntable counterweights are installed on turntable rear side, three configurations of 110t, 130t and 150t are shown as follows:

- (1) 110t: counterweight box 2 × 15t, counterweight slab 8 × 10t;
- (2) 130t: counterweight box 2 × 15t, counterweight slab 10 × 10t;
- (3) 150t: counterweight box 2 × 15t, counterweight slab 12 × 10t;

Superlift counterweight is 230t in total, the composition is as follows:

Superlift counterweight tray 1 × 10t, counterweight slab 22 × 10t (4 counterweight slabs are borrowed from turntable counterweight).

Hook block

The configurations of hook blocks are as follows:

Name	400t	350t	320t	260t
Weight (t)	6.8	6.2	6.0	4.6
Pulley number	2 × 7	13	2 × 5	9
Max. parts of line	2 × 14	1 × 27	2 × 11	1 × 19

Name	200t	160t	50t	16t
Weight (t)	4.2	3.9	2.5	0.9
Pulley number	7	5	1	0
Max. parts of line	1 × 14	1 × 11	1 × 3	1

Centralized lubrication system

The use of progressive centralized lubrication system is controlled by computer programming. It can add lubricating oil automatically point by point, so as to ensure that each point is lubricated sufficiently and make crane maintenance more easy and convenient.

Safety Protection Measures

The safety protection functions of this crane are as follows: Assembly mode & working mode exchange function, emergency stop function, LMI system, hydraulic system safety protection function, rope over-wind protection function, rope over-release protection function, anti-misoperation function, ratchet locking function, slewing locking function, boom backstop function, boom angle limit function, hook latch, hoist height limit function, video monitoring function, sound and light alarm function, lightning protection function. At the same time, it is equipped with illuminator light, rearview mirror, height mark lamp, anemometer, gradiometer and etc.

Assembly mode & working mode changeover switch

In Assembly mode, over-wind protection device, boom angle limiter and load moment limiter are all out of service, in order to facilitate crane assembly; in working mode, all safety devices work normally.

Emergency stop function

This crane has emergency stop function, all crane movements can be stopped quickly in case of emergency.

LMI system

Detection function: LMI can automatically detect parameters such as boom angle and lifting weight.

Display function: 10.4-inch high-definition LCD display, show important parameters in lifting operation through text and graphics, such as load moment percentage, actual lifting weight, rated lifting weight, radius, boom length, angle, maximum lifting height, working condition code, parts of line, limit angle and information code.

Warning function: with complete pre-alarm and overload stop function. If it is detected that the actual weight exceeds the rated lifting capacity or boom angle exceeds the maximum value, LMI will send alarm and limit the current movement of the crane.

The system has self-diagnosis function.

Hydraulic system safety protection function

Hydraulic system is equipped with hydraulic balance valve, hydraulic relief valve and other devices to ensure the stable and safe work of the system.

Rope over-wind protection function

There is an over-wind protection device on boom head to prevent rope from being over-wound. When main/auxiliary winch hoists up to a certain lifting height, the over-wind warning light on display will be on, and load moment limiter will stop hoisting up movements at the same time.

Rope over-release protection function

Rope end limiter is set on each hoist winch to prevent wire rope from over-releasing. When there are only three loops of rope left on winch, the over-release warning light on display will be on, and the movement of lowering down will be stopped at the same time.

Anti-misoperation function

The handles have anti-misoperation function. A safety protection switch is set at the front of the handle. If the switch is not pressed, all movement signals are shielded, and the handle will not work to prevent operation error.

Ratchet locking function

Ratchet locking device is used to lock the luffing winch so that boom is stopped and placed safely at non-working state.

Slewing locking function

Slewing locking device is used to lock superstructure slewing when the crane is stopped.

Backstop function

Main boom, superlift mast, tower jib and tower jib struts are equipped with backstop devices to prevent boom from tilting backward.

Boom angle limit function

In working mode, when boom is elevated to the max. working angle, boom raising will be stopped under the control of load moment limiter and hoist limit switch; when boom is elevated to the min. working angle, boom lowering will be stopped under the control of load moment limiter, and a sound warning will be given. The upper and lower limits of tower jib are controlled by angle limit switch.

PARTS AND SYSTEM DESCRIPTION OF THE CRANE

Hook latch

All lifting hooks are equipped with latch to prevent the suspended rope on the hook head from falling off.

Hoist height limit function

Suspended height limit device is installed on boom head, when the hook contacts the height limit device, the lifting movement will be stopped to avoid damage to the wire rope.

Closed circuit monitoring system

The system is composed of camera and monitor. It is used to monitor the hoist winches, boom luffing winch, jib luffing winches and etc.

Sound and light warning function

It is equipped with tri-color warning light and audio/video alarm. It can display the load and movement status of the vehicle, flash the lights and send sound alarm to alert the driver and people outside the vehicle.

Lightning protection function

Lightning protection grounding system and surge protector system are optionally configured for this crane to reduce lightning strike possibility of the control system.

Illuminator light

There are illuminator lights in front of turntable, above the cab and inside the cab for lighting.

Rearview mirror

It is outside the operator's cab so that the driver can observe the situation behind the machine.

Height mark lamp

It is located on boom tip for high level operation warning.

Anemometer

It can detect the current wind speed and send signal to the monitor in operator's cab to remind the operator for safe operation in wind load.

Gradiometer

It is equipped with electronic and mechanical gradiometers, which can show the ground gradient and provide reference for the operator.

MAIN TECHNICAL PARAMETERS

Items		Unit	Parameters	
Max. rated lifting capacity	Standard working condition	Heavy boom	t	400
		Light boom	t	220
		Tower jib	t	150
		Fixed jib	t	200
		TBM jib	t	350 (main hook), 185 (aux. hook)
	Superlift working condition	Goose head jib	t	119
		Heavy boom	t	400
		Light boom	t	216
		Tower jib	t	220
		TBM jib	t	400 (main hook), 185 (aux. hook)
Max. lifting moment	Standard working condition	t.m	2600	
	Superlift working condition	t.m	5200	
Dimension	Standard working condition	Heavy boom length	m	24 ~ 84
		Light boom length	m	42 ~ 108
		Tower jib length	m	24 ~ 72
		Fixed jib length	m	24~78+9
		Fixed jib angle	°	10°
	Superlift working condition	TBM jib length	m	24+9
		Goose head jib length	m	66~84+7
		Heavy boom length	m	36 ~ 84 (option: 96)
		Light boom length	m	72 ~ 126
		Tower jib length	m	24 ~ 84
Speed	TBM jib length	m	36+9	
	Goose head jib length	m	78-84(option: 96)+7	
	Hoist winch max. single line speed	m/min	130	
	Boom luffing winch max. single line speed	m/min	2 × 51	
	Tower jib luffing winch max. single line speed	m/min	100	
Engine rated power	Superlift luffing winch max. single line speed	m/min	105	
	Max. slewing speed (no load)	rpm	1.16	
	Max. travel speed	km/h	0.9	
	Total crane weight (24m heavy boom, 350t hook block)	Kw/rpm	338/1900	
	Mean ground pressure	t	350	
Grade-ability (with base boom)	MPa	0.146		
	20%			
	Max. mass of single unit in transport state	t	48	
Max. dimension of single unit (turntable) in transport state (L × W × H)	m	11.5 × 3 × 3.4		

MAIN TECHNICAL PARAMETERS

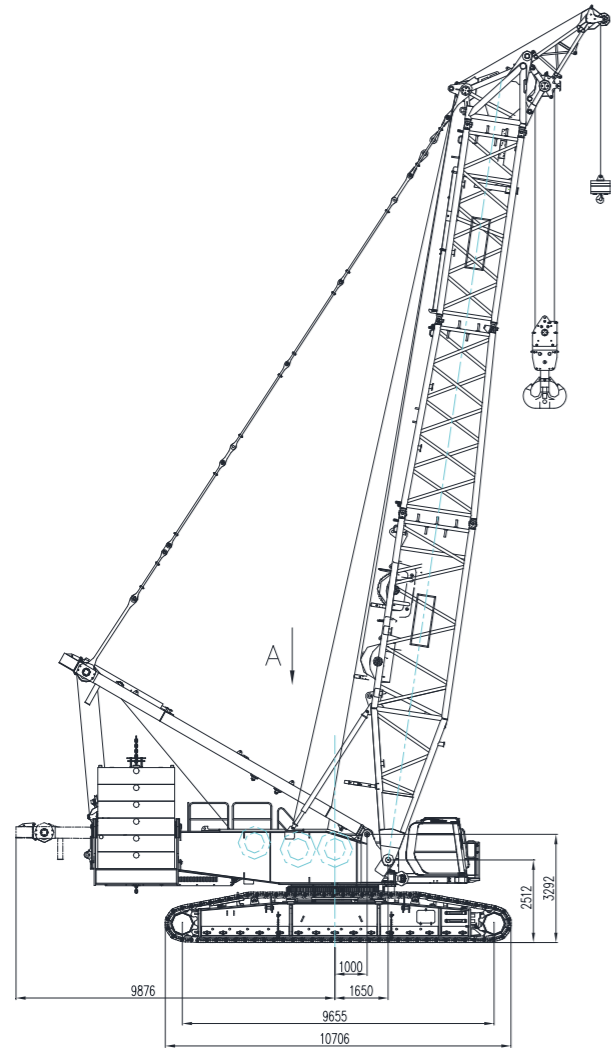

Remove boom, mast and etc.

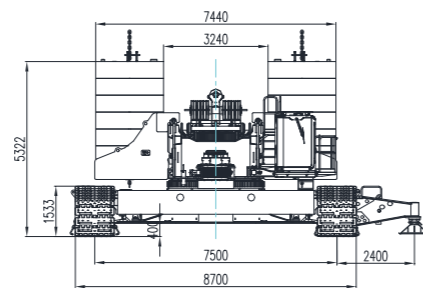

A direction (remove boom, mast and etc.)

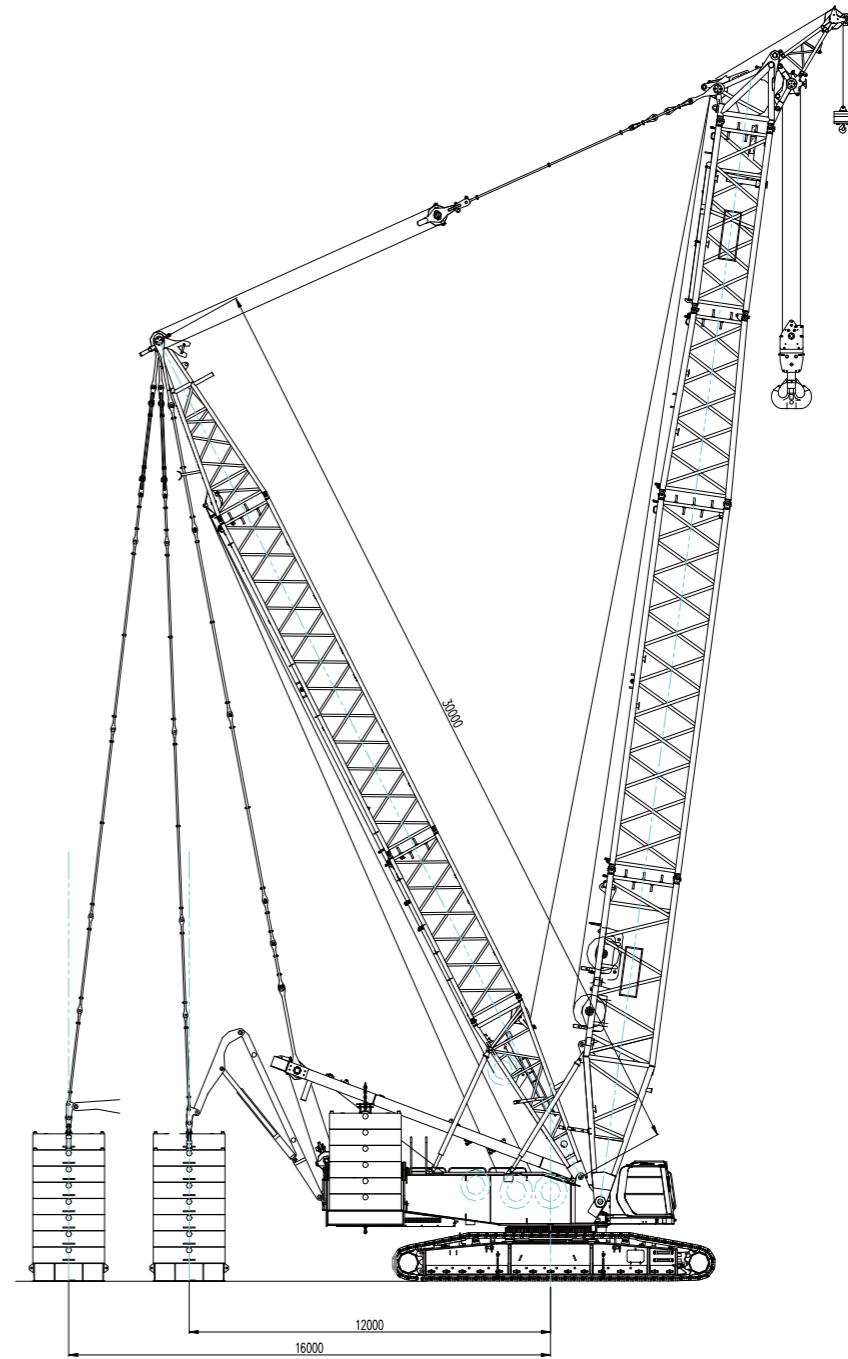
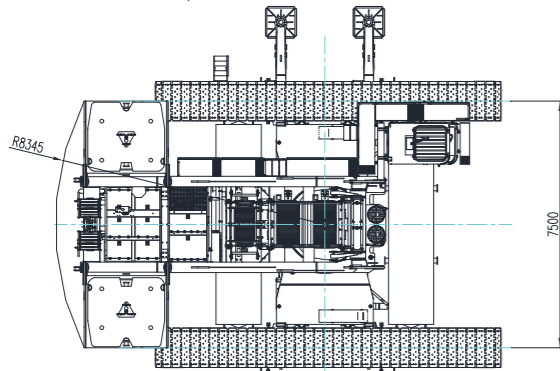

LIFTING CAPACITY TABLE IN TYPICAL WORKING CONDITIONS

1. Standard heavy boom working condition (HB)

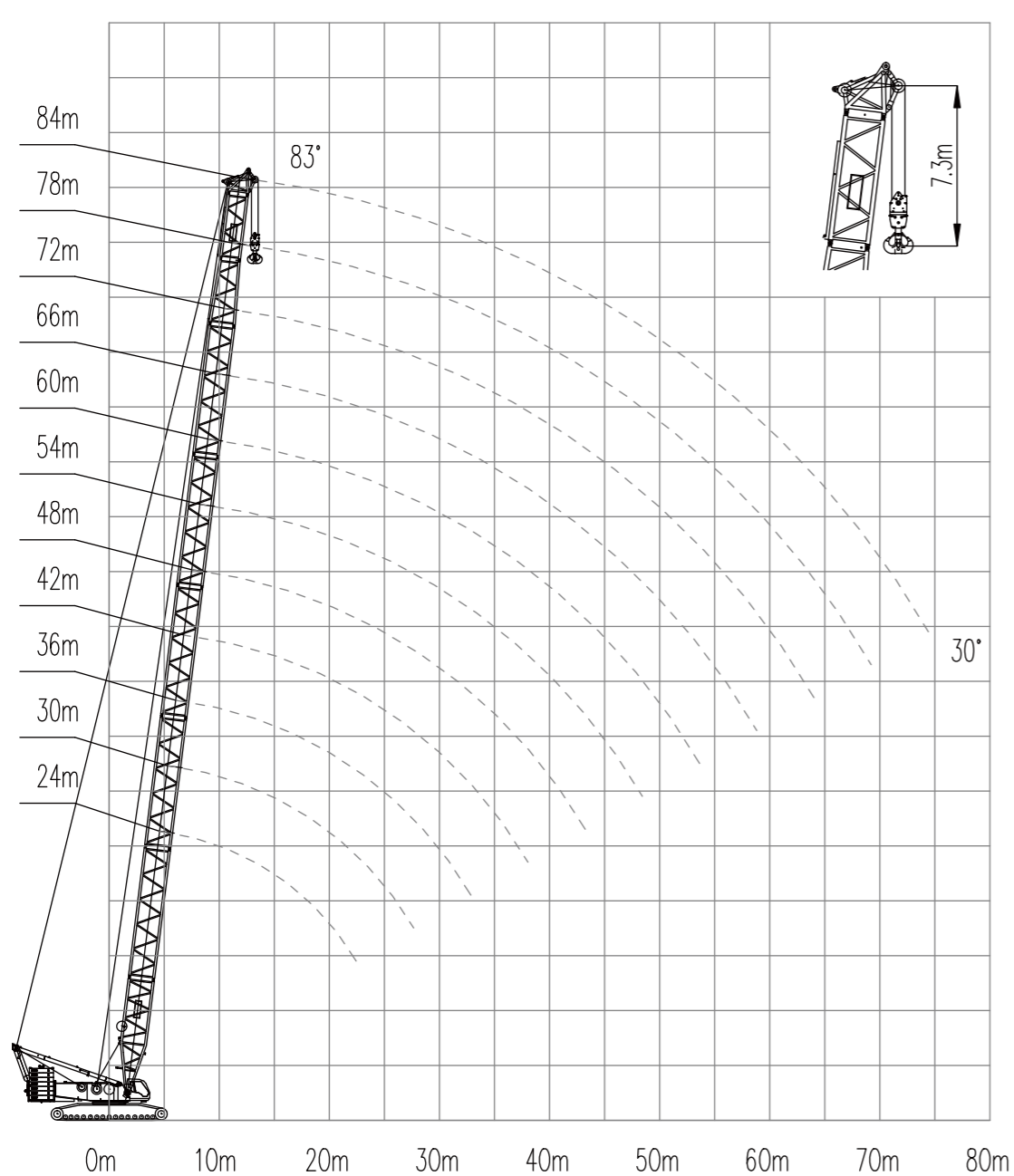

150t turntable counterweight +40t car-body counterweight

Radius (m)	Boom length (m)											
	24	30	36	42	48	54	60	66	72	78	84	
6	400.0											
7	357.5	356.1										
8	315.7	314.4	313.0									
9	276.2	275.8	273.5	265.2	240.4							
10	244.1	241.3	234.8	228.6	213.7	203.4						
12	182.4	182.5	182.4	178.1	174.1	166.7	159.7	153.5	147.2			
14	155.0	154.5	151.3	148.0	144.7	140.5	135.1	130.2	125.2	120.7	116.2	
16	127.3	127.2	126.6	124.0	121.3	120.0	116.4	112.5	108.4	104.7	100.9	
18	107.4	107.3	107.0	106.1	104.0	102.8	100.8	98.6	95.1	91.9	88.6	
20	92.4	92.3	92.0	91.5	90.6	89.5	87.8	86.3	84.2	81.4	78.6	
22	80.7	80.7	80.4	79.8	79.2	78.5	77.3	76.0	74.5	72.8	70.3	
24		71.2	71.0	70.4	69.8	69.0	68.3	67.6	66.2	65.0	63.1	
26		63.5	63.3	62.7	62.0	61.3	60.6	60.2	59.2	58.1	56.7	
28		57.0	56.8	56.3	55.7	54.9	54.1	53.7	52.8	52.3	51.1	
30			51.4	50.8	50.2	49.4	48.6	48.2	47.3	46.7	46.0	
32			46.6	46.2	45.5	44.7	43.9	43.5	42.6	42.0	41.3	
34				42.0	41.5	40.6	39.9	39.4	38.5	37.9	37.1	
36				38.4	37.8	37.0	36.3	35.8	35.0	34.4	33.5	
38				35.3	34.7	33.9	33.1	32.6	31.8	31.2	30.4	
40					31.9	31.1	30.3	29.8	28.9	28.3	27.5	
42					29.3	28.5	27.8	27.3	26.5	25.9	25.0	
44						26.3	25.5	25.1	24.1	23.5	22.7	
46						24.2	23.4	23.0	22.1	21.5	20.7	
48						22.2	21.6	21.1	20.2	19.6	18.7	
50							19.8	19.4	18.5	17.9	17.1	
52							18.2	17.8	16.9	16.3	15.5	
54							16.8	16.4	15.5	14.9	14.0	
56								15.0	14.1	13.5	12.6	
58								13.7	12.8	12.3	11.4	
60									11.7	11.1	10.3	
62									10.6	10.0	9.1	
64									9.6	9.0	8.1	
66										8.0	7.2	
68										7.2	6.3	
70											5.5	

LIFTING CAPACITY TABLE IN TYPICAL WORKING CONDITIONS

2. Standard light boom working condition (LB)

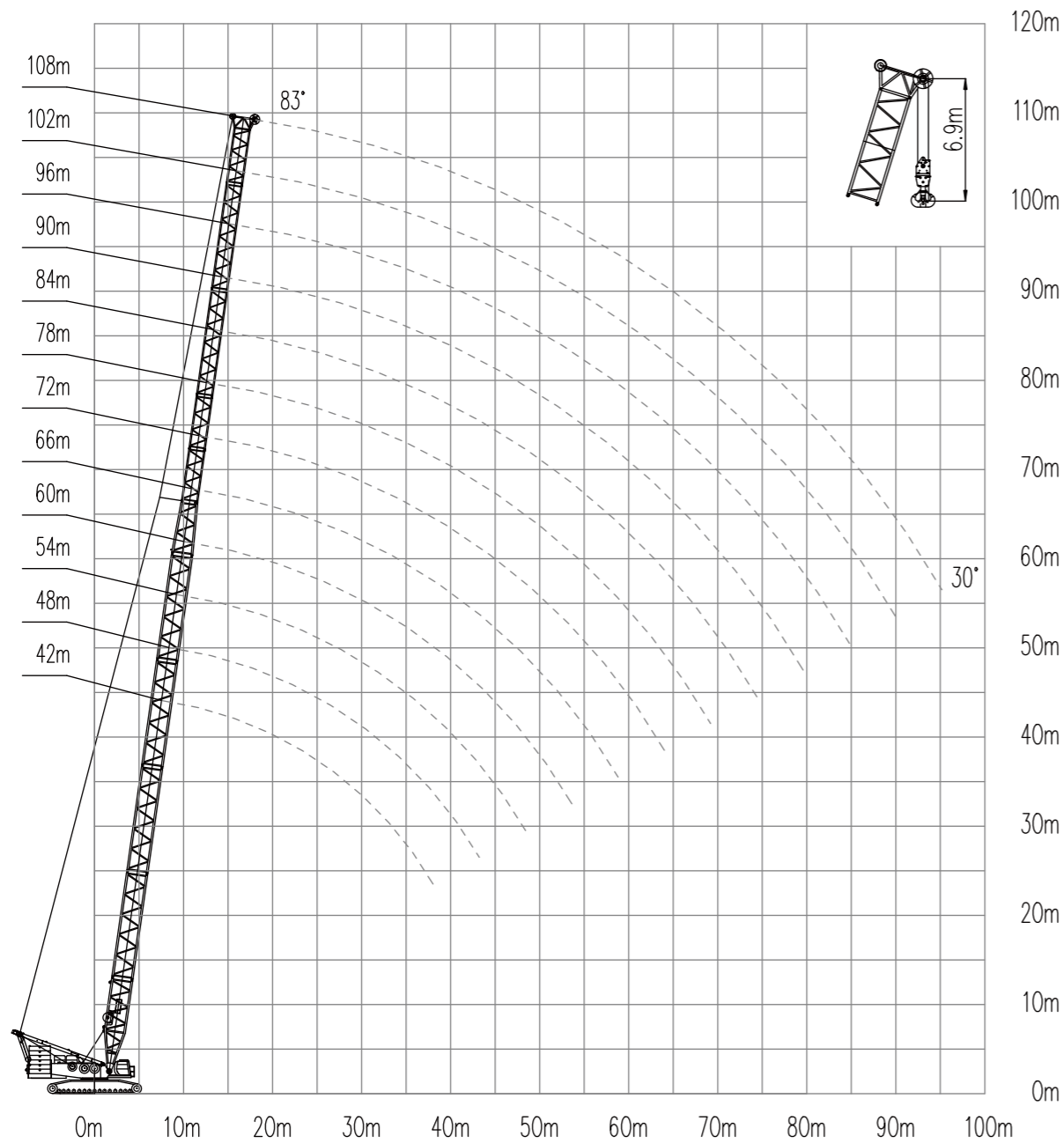

150t turntable counterweight +40t car-body counterweight

Radius (m)	Boom length											
	42	48	54	60	66	72	78	84	90	96	102	108
9	220.0	217.6										
10	209.0	208.8	196.3									
12	179.5	172.9	165.8	159.6	153.2	144.4						
14	146.5	143.4	140.5	135.8	130.7	126.6	122.1	110.1	104.7			
16	123.4	120.8	119.4	117.5	113.6	110.3	106.8	103.6	98.0	85.2	76.5	
18	106.3	104.1	103.0	101.4	99.5	97.5	94.4	91.8	88.8	79.6	74.6	61.8
20	92.4	91.2	90.2	88.9	87.2	86.0	84.4	82.2	79.4	77.3	69.8	60.2
22	81.1	80.6	80.0	78.9	77.3	76.3	75.0	73.8	71.6	69.8	67.6	58.7
24	72.1	71.4	70.9	70.7	69.3	68.3	67.1	66.1	64.8	63.4	61.4	57.2
26	64.6	64.0	63.4	63.2	62.4	61.7	60.5	59.7	58.4	57.5	56.0	54.4
28	58.4	57.8	57.2	56.9	56.1	56.1	55.0	54.2	53.0	52.2	51.0	49.8
30	53.2	52.5	51.9	51.7	50.8	50.7	50.2	49.5	48.3	47.6	46.5	45.6
32	48.6	48.0	47.3	47.1	46.3	46.2	45.6	45.3	44.3	43.5	42.5	41.6
34	44.7	44.1	43.4	43.1	42.4	42.2	41.6	41.4	40.6	40.0	39.0	38.2
36	41.2	40.7	40.0	39.7	39.0	38.8	38.2	37.9	37.1	36.9	35.9	35.1
38	38.2	37.5	37.0	36.7	35.8	35.7	35.2	34.9	34.1	33.8	33.2	32.4
40		34.9	34.2	34.0	33.2	33.0	32.4	32.1	31.4	31.1	30.4	29.9
42		32.4	31.7	31.5	30.7	30.6	30.0	29.6	28.9	28.6	27.9	27.5
44			29.5	29.4	28.5	28.4	27.7	27.5	26.7	26.4	25.7	25.3
46			27.6	27.4	26.5	26.4	25.8	25.5	24.7	24.4	23.8	23.2
48			25.7	25.6	24.7	24.6	23.9	23.7	22.9	22.6	21.9	21.4
50				23.8	23.1	22.9	22.3	22.0	21.2	20.9	20.2	19.8
52				22.3	21.6	21.4	20.8	20.5	19.7	19.4	18.7	18.2
54				20.9	20.1	20.0	19.4	19.1	18.2	18.0	17.3	16.8
56					18.8	18.7	18.1	17.9	17.0	16.7	16.0	15.5
58					17.6	17.5	16.9	16.6	15.8	15.5	14.8	14.3
60						16.3	15.8	15.5	14.6	14.3	13.7	13.2
62						15.3	14.7	14.4	13.6	13.3	12.6	12.2
64						14.3	13.8	13.5	12.6	12.4	11.7	11.2
66							12.8	12.5	11.8	11.4	10.7	10.3
68							12.0	11.7	10.9	10.5	9.9	9.4
70								10.9	10.1	9.8	9.1	8.6
74								9.4	8.6	8.3	7.6	7.1
78									7.2	6.9	6.3	5.8

LIFTING CAPACITY TABLE IN TYPICAL WORKING CONDITIONS

3. Standard tower jib working condition (HW)

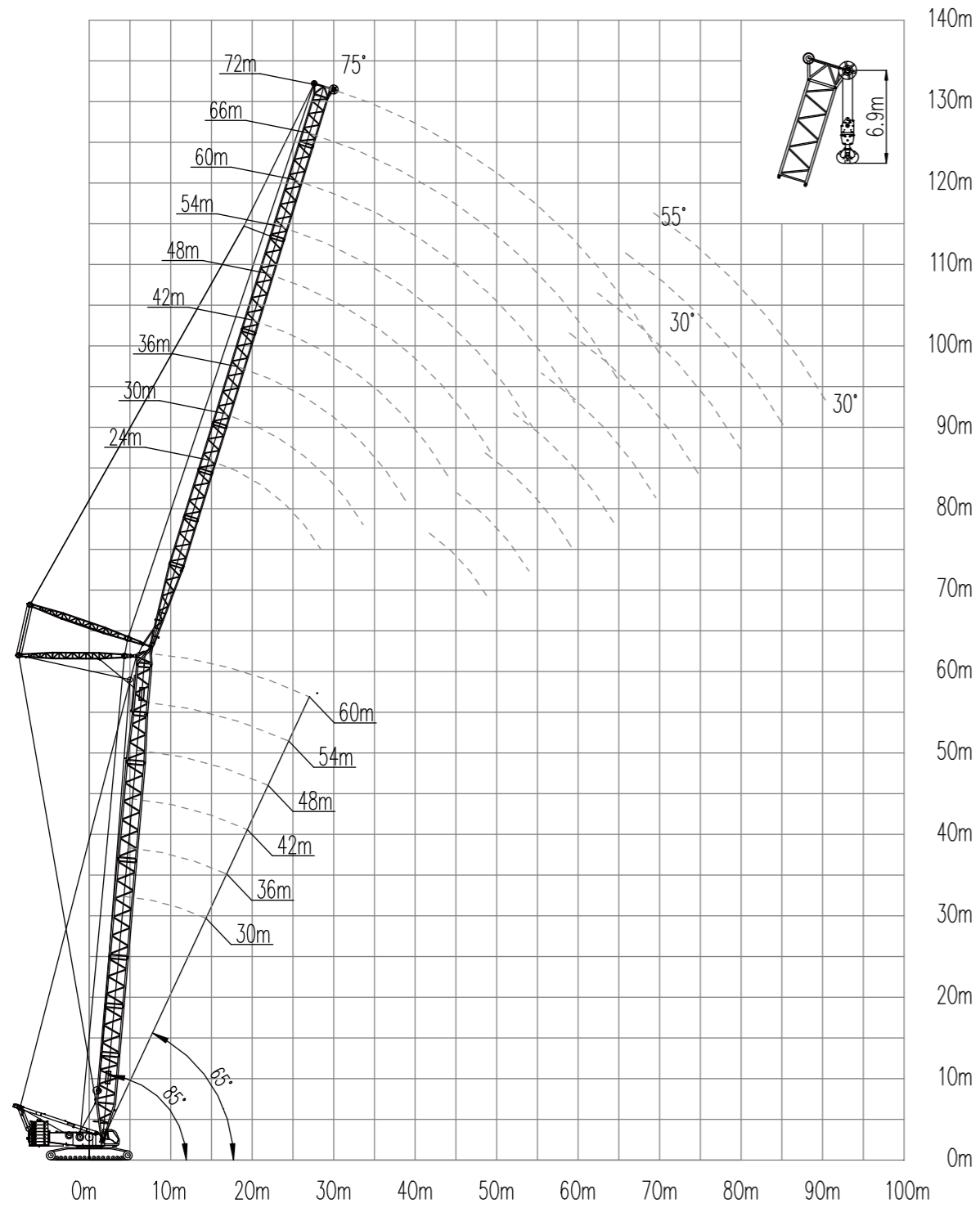

Boom length 30m, boom angle 85° , turntable counterweight 150t+ car-body counterweight 40t

Radius (m)	Tower jib length (m)								
	24	30	36	42	48	54	60	66	72
14	150.0								
16	128.0	123.7	119.8						
18	111.5	109.6	106.5	103.2					
20	98.4	96.8	95.2	92.9	90.1				
22	88.0	86.6	85.3	83.8	81.9	79.6			
24	78.6	78.3	77.1	75.8	74.4	72.9	70.7	62.1	
26	70.7	70.7	70.2	69.0	67.8	66.7	65.0	61.8	52.5
28		64.2	63.9	63.3	62.1	61.1	59.9	58.7	52.2
30		58.7	58.5	58.1	57.2	56.4	55.2	54.3	51.7
32			53.8	53.4	52.8	52.2	51.0	50.3	49.4
34			49.6	49.3	48.8	48.3	47.5	46.7	45.8
36			46.1	45.7	45.2	44.7	44.1	43.5	42.7
38				42.6	42.0	41.6	41.0	40.6	39.9
40				39.7	39.2	38.8	38.2	37.8	37.2
42				37.1	36.7	36.4	35.6	35.3	34.8
44					34.4	34.0	33.4	33.0	32.5
46					32.3	32.1	31.4	31.0	30.5
48						30.2	29.5	29.1	28.6
50						28.4	27.8	27.4	26.9
52						26.8	26.2	25.9	25.3
54							24.7	24.4	23.9
56							23.4	23.1	22.6
58								21.8	21.3
60								20.7	20.2
62								19.6	19.1
64									18.0
66									17.1
68									16.3

LIFTING CAPACITY TABLE IN TYPICAL WORKING CONDITIONS

Boom length 36m, boom angle 85° , turntable counterweight 150t+ car-body counterweight 40t

Radius (m)	Tower jib length (m)								
	24	30	36	42	48	54	60	66	72
14	140.8								
16	123.2	119.1							
18	109.5	106.0	102.8	99.6					
20	96.9	95.3	92.7	89.9	87.1				
22	86.8	85.4	83.9	81.8	79.2	77.1			
24	78.3	77.2	76.0	74.6	72.7	70.7	68.4		
26	70.5	70.3	69.3	68.1	66.8	65.1	63.1	58.9	50.3
28		63.9	63.5	62.4	61.3	60.3	58.5	57.0	49.9
30		58.5	58.3	57.6	56.5	55.6	54.3	52.9	49.6
32		53.7	53.6	53.1	52.4	51.5	50.4	49.4	47.9
34			49.4	49.1	48.5	47.9	46.8	46.1	44.8
36			45.9	45.5	44.9	44.6	43.7	43.0	42.0
38				42.4	41.8	41.5	40.7	40.1	39.3
40				39.6	39.0	38.6	38.0	37.6	36.8
42				36.9	36.5	36.1	35.4	35.1	34.5
44					34.2	33.8	33.2	32.8	32.2
46					32.1	31.9	31.2	30.8	30.3
48						30.0	29.3	29.0	28.4
50						28.3	27.6	27.3	26.7
52						26.7	26.0	25.7	25.1
54							24.6	24.3	23.7
56							23.2	22.9	22.4
58							22.0	21.7	21.2
60								20.6	20.0
62								19.5	19.0
64									18.0
66									17.0
68									16.1

Boom length 42m, boom angle 85° , turntable counterweight 150t+ car-body counterweight 40t

Radius (m)	Tower jib length (m)								
	24	30	36	42	48	54	60	66	72
14	135.1								
16	118.6	114.7							
18	105.7	102.3	99.3						
20	95.2	92.3	89.6	86.9	84.2				
22	85.4	83.9	81.6	79.1	76.7	74.6			
24	77.3	76.0	74.8	72.6	70.4	68.4	65.7		
26	70.3	69.4	68.2	66.9	65.0	63.2	61.1	55.8	
28		63.7	62.7	61.6	60.2	58.6	56.7	55.2	47.6
30		58.2	57.9	56.9	55.7	54.5	52.7	51.3	47.4
32		53.5	53.3	52.7	51.7	50.8	49.2	47.9	46.4
34			49.3	48.8	48.1	47.3	46.1	44.8	43.4
36			45.7	45.3	44.7	44.1	43.1	42.1	40.8
38				42.1	41.6	41.2	40.3	39.6	38.4
40				39.4	38.8	38.4	37.7	37.1	36.1
42				36.8	36.3	35.9	35.3	34.9	34.1
44					34.0	33.7	33.0	32.6	32.1
46					32.0	31.7	30.9	30.6	30.0
48					30.1	29.8	29.1	28.8	28.2
50						28.1	27.4	27.1	26.5
52						26.5	25.9	25.5	24.9
54							24.4	24.1	23.5
56							23.1	22.7	22.2
58							21.8	21.5	21.0
60								20.4	19.8
62								19.4	18.8
64									17.8
66									16.8
68									16.0

LIFTING CAPACITY TABLE IN TYPICAL WORKING CONDITIONS

Boom length 48m, boom angle 85° , turntable counterweight 150t+ car-body counterweight 40t

Radius (m)	Tower jib length (m)								
	24	30	36	42	48	54	60	66	72
16	114.1	110.4							
18	101.9	98.6	95.7						
20	91.9	89.1	86.5	83.8					
22	83.7	81.2	78.9	76.5	74.2				
24	76.1	74.4	72.4	70.2	68.1	66.2	61.7		
26	69.5	68.3	66.8	64.9	62.9	61.1	59.1	52.7	
28		62.8	61.8	60.2	58.3	56.7	54.8	52.5	45.2
30		57.9	57.1	56.0	54.3	52.8	51.0	49.6	45.0
32		53.2	53.0	52.0	50.8	49.4	47.7	46.4	44.7
34			49.0	48.4	47.4	46.2	44.7	43.4	42.0
36			45.4	45.0	44.3	43.5	41.9	40.8	39.5
38			42.3	41.9	41.4	40.7	39.5	38.4	37.1
40				39.1	38.5	38.2	37.2	36.2	35.0
42				36.6	36.1	35.7	35.0	34.2	33.0
44					33.8	33.5	32.7	32.3	31.2
46					31.8	31.4	30.7	30.4	29.5
48					29.9	29.6	28.9	28.5	27.9
50						27.9	27.2	26.9	26.2
52						26.3	25.7	25.3	24.7
54							24.3	23.9	23.3
56							22.9	22.6	22.0
58							21.7	21.3	20.8
60								20.2	19.6
62								19.2	18.6
64								18.1	17.6
66									16.7
68									15.8

Boom length 54m, boom angle 85° , turntable counterweight 150t+ car-body counterweight 40t

Radius (m)	Tower jib length (m)								
	24	30	36	42	48	54	60	66	72
16	109.6								
18	98.1	94.9	92.1						
20	88.7	85.9	83.5	80.8					
22	80.8	78.4	76.1	73.9	71.5				
24	74.3	72.0	70.0	67.9	65.8	63.9			
26	68.4	66.6	64.7	62.7	60.8	59.1	57.1	49.6	
28	62.9	61.8	60.1	58.3	56.4	54.8	52.9	49.4	42.8
30		57.2	56.0	54.3	52.5	51.1	49.4	48.0	42.6
32		52.9	52.3	50.9	49.2	47.8	46.1	44.8	42.3
34			48.7	47.7	46.2	44.8	43.1	42.0	40.6
36			45.1	44.7	43.4	42.1	40.6	39.5	38.1
38			42.0	41.6	40.9	39.8	38.2	37.1	35.8
40				38.8	38.3	37.5	36.1	35.1	33.7
42				36.4	35.8	35.4	34.1	33.1	31.9
44				34.1	33.6	33.2	32.2	31.3	30.2
46					31.6	31.2	30.5	29.7	28.6
48					29.7	29.3	28.7	28.2	27.1
50						27.6	27.0	26.6	25.7
52						26.1	25.5	25.1	24.4
54						24.6	24.1	23.7	23.1
56							22.7	22.4	21.8
58							21.5	21.2	20.6
60								20.0	19.5
62								19.0	18.4
64								18.0	17.4
66									16.5
68									15.6
70									14.9

LIFTING CAPACITY TABLE IN TYPICAL WORKING CONDITIONS

Boom length 60m, boom angle 85°, turntable counterweight 150t+ car-body counterweight 40t

Radius (m)	Tower jib length (m)								
	24	30	36	42	48	54	60	66	72
16	105.2								
18	94.4	91.4							
20	85.4	82.8	80.4	77.8					
22	78.0	75.7	73.4	71.2	68.9				
24	71.7	69.6	67.6	65.5	63.5	61.2			
26	66.3	64.3	62.5	60.5	58.7	57.0	53.3		
28	61.7	59.8	58.1	56.3	54.5	52.9	51.0	46.2	40.3
30		55.7	54.2	52.5	50.8	49.4	47.6	45.2	40.0
32		52.3	50.8	49.2	47.6	46.2	44.5	43.2	39.4
34		48.5	47.7	46.2	44.7	43.3	41.6	40.5	38.0
36			44.8	43.4	42.0	40.7	39.2	38.1	36.7
38			41.7	41.0	39.6	38.4	36.8	35.8	34.5
40				38.5	37.4	36.3	34.8	33.7	32.5
42				36.1	35.4	34.3	32.9	32.0	30.7
44				33.8	33.3	32.5	31.2	30.2	29.0
46					31.3	30.9	29.5	28.7	27.4
48					29.4	29.0	28.1	27.2	26.0
50						27.4	26.7	25.9	24.7
52						25.9	25.2	24.5	23.5
54						24.4	23.8	23.4	22.3
56							22.5	22.1	21.2
58							21.2	20.9	20.2
60							20.1	19.8	19.2
62								18.7	18.1
64								17.8	17.2
66									16.3
68									15.4
70									14.6

4. Standard goose head jib working condition (HJ)

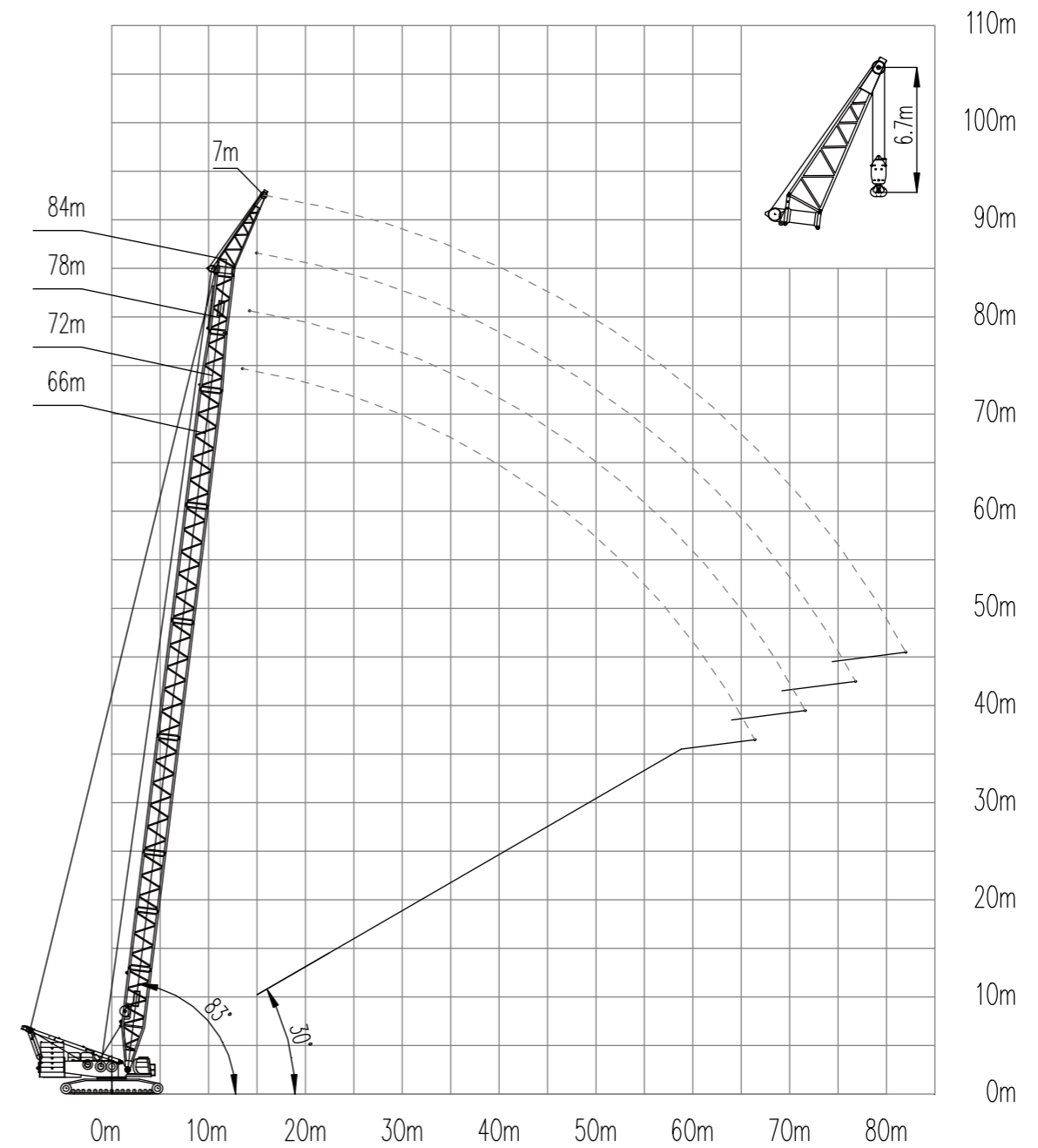

LIFTING CAPACITY TABLE IN TYPICAL WORKING CONDITIONS

Turntable counterweight 150t+car-body counterweight 40t

Radius (m)	Boom length			
	66	72	78	84
14	119.7	116.4	116.4	
15	119.7	115.7	115.3	105.5
16	115.5	111.6	108.0	101.2
18	98.8	98.5	95.4	92.2
20	87.9	85.2	85.2	82.3
22	77.9	76.4	74.3	71.8
24	69.6	68.3	67.0	65.0
26	62.8	61.5	60.3	59.1
28	56.7	55.7	54.6	53.4
30	51.3	50.5	49.7	48.5
32	46.6	45.8	45.2	44.2
34	42.5	41.6	41.1	40.3
36	38.9	38.0	37.4	36.7
38	35.7	34.9	34.3	33.5
40	32.9	32.0	31.4	30.6
42	30.4	29.5	28.9	28.0
44	28.1	27.3	26.7	25.8
46	26.0	25.1	24.5	23.7
48	24.2	23.3	22.7	21.8
50	22.4	21.5	21.0	20.1
52	20.9	20.0	19.4	18.4
54	19.4	18.5	17.9	17.0
56	18.0	17.2	16.6	15.6
58	16.8	15.9	15.3	14.4
60	15.6	14.7	14.2	13.2
62	14.6	13.7	13.1	12.1
64	13.5	12.6	12.0	11.2
66	12.5	11.6	11.1	10.2
68		10.8	10.2	9.3
70		9.9	9.3	8.4
74			7.8	6.9
78				5.4

5. Standard fixed jib working condition (HF)

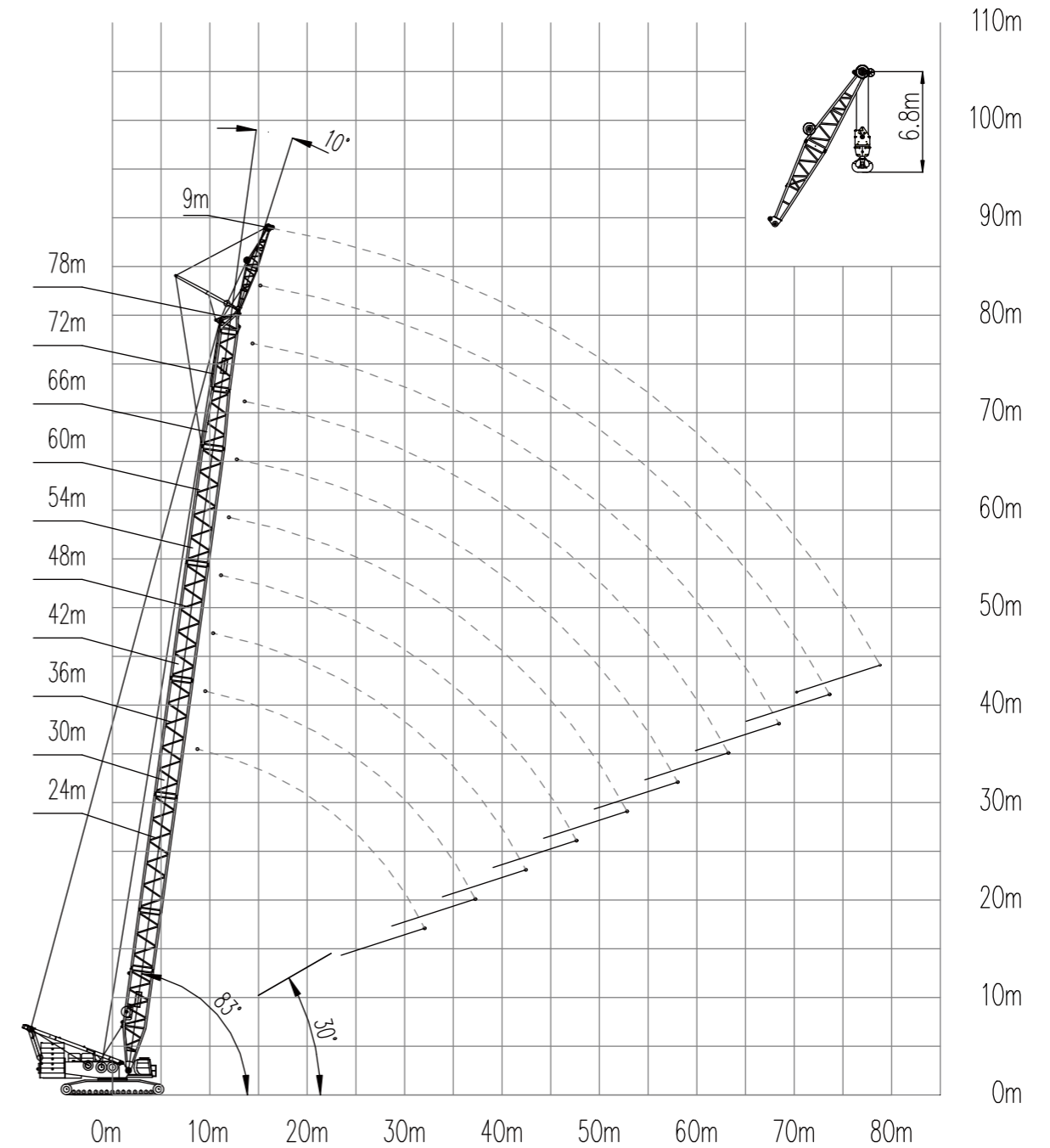

LIFTING CAPACITY TABLE IN TYPICAL WORKING CONDITIONS

Fixed jib length 9m, jib offset angle 10°, turntable counterweight 150t+car-body counterweight 40t

Radius (m)	Boom length (m)									
	24	30	36	42	48	54	60	66	72	78
9	200.0									
10	200.0	190.0	190.0							
12	185.5	181.2	174.2	166.8	159.8					
14	150.4	147.2	143.9	140.4	135.0	129.8	124.8	117.2		
16	125.4	123.3	120.7	119.1	116.3	112.0	107.9	104.3	100.5	97.0
18	105.9	105.4	103.6	102.1	100.2	98.1	94.6	91.5	88.2	85.2
20	91.2	90.6	90.1	89.0	87.3	85.6	83.8	81.0	78.2	75.5
22	79.7	79.1	78.6	77.8	77.0	75.4	73.9	72.4	69.8	67.5
24	70.5	69.9	69.3	68.6	67.8	67.1	65.6	64.5	62.7	60.6
26	63.0	62.3	61.8	61.0	60.2	59.5	58.7	57.7	56.3	54.7
28	56.6	56.1	55.4	54.6	53.9	53.1	52.3	51.8	50.6	49.6
30	51.2	50.6	50.1	49.3	48.5	47.7	46.8	46.4	45.5	44.7
32	46.6	46.1	45.4	44.7	43.9	43.0	42.2	41.6	40.9	40.2
34		42.0	41.4	40.7	39.9	39.0	38.2	37.6	36.8	36.1
36		38.5	37.9	37.1	36.4	35.5	34.7	34.1	33.2	32.6
38			34.8	34.0	33.3	32.4	31.5	31.0	30.0	29.5
40			32.0	31.3	30.5	29.6	28.7	28.1	27.3	26.6
42			29.5	28.8	28.0	27.1	26.2	25.7	24.8	24.1
44				26.5	25.7	24.9	23.9	23.4	22.5	21.9
46				24.4	23.7	22.8	21.9	21.4	20.4	19.9
48					21.9	21.0	20.0	19.5	18.6	18.0
50					20.1	19.3	18.3	17.8	16.9	16.2
52					18.5	17.7	16.8	16.2	15.3	14.7
54						16.2	15.4	14.8	13.9	13.2
56						14.9	14.1	13.5	12.5	11.9
58						13.7	12.8	12.3	11.3	10.6
60							11.6	11.1	10.2	9.5
62							10.5	10.0	9.1	8.5
64								9.0	8.1	7.4
66								8.0	7.1	6.5
68								7.1	6.3	5.6
70									5.4	

6. Standard TBM working condition (HFS)

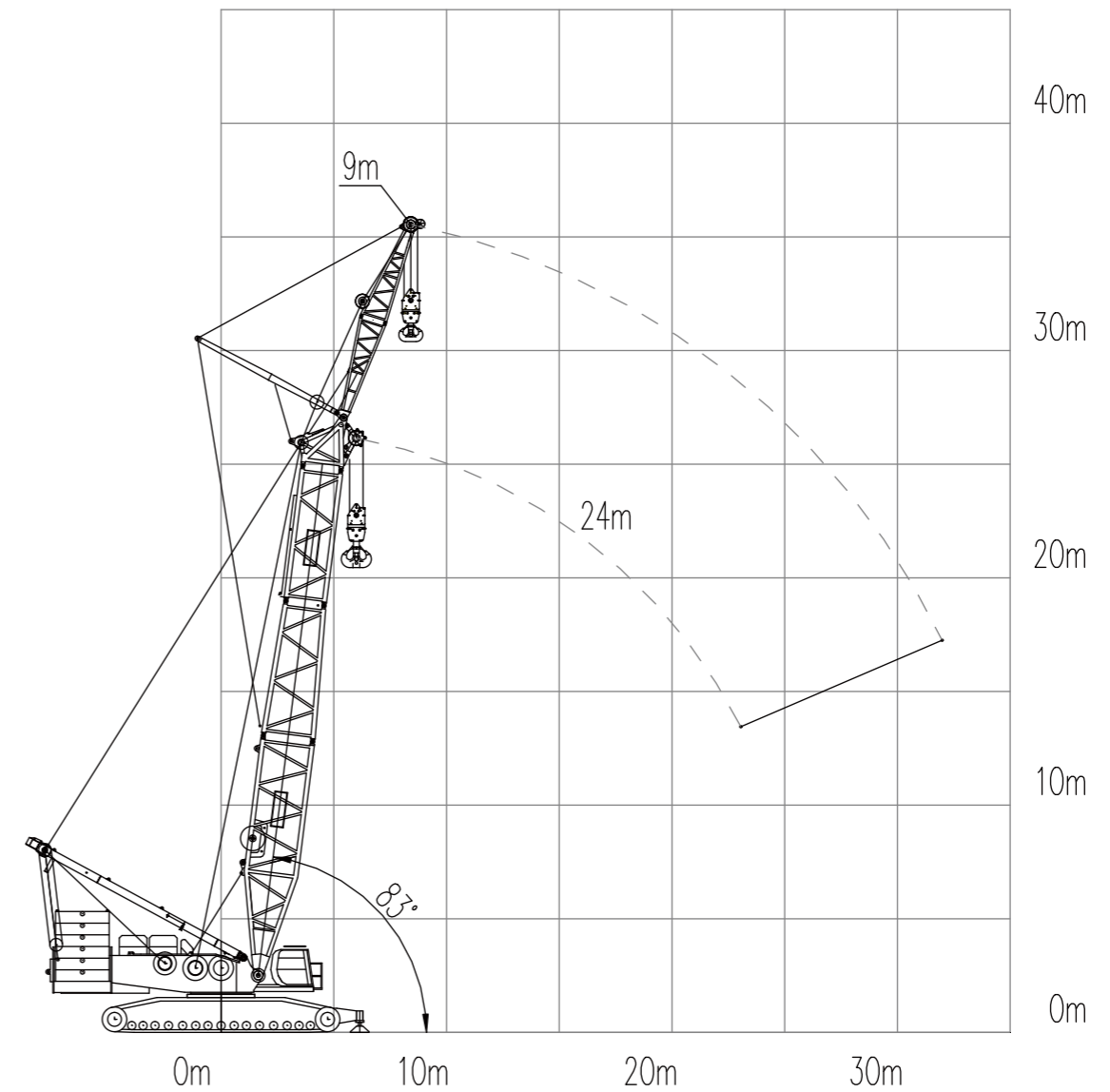

LIFTING CAPACITY TABLE IN TYPICAL WORKING CONDITIONS

Turntable counterweight		150t		Car-body counterweight		40t	
Boom length		24m		Jib length		9m	
Jib angle		10°					
Boom angle	Main hook radius	Main hook load	Aux. hook radius	Aux. hook load	Total load of main and aux. hooks		
°	(m)	(t)	(m)	(t)	(t)		
82.8	6	350.0	8.4	185	350.0		
80.4	7	350.0	9.8	185	302.5		
77.9	8	309.4	11.2	185	260.3		
75.4	9	270.7	12.6	177.8	228.0		
72.9	10	239.2	14.0	150.2	195.8		
70.3	11	209.0	15.4	129.5	168.5		
67.7	12	178.7	16.8	113.1	147.4		
65.0	13	159.5	18.2	100.1	130.7		
62.3	14	141.1	19.6	89.3	117.1		
59.5	15	125.9	20.9	80.3	105.8		
56.6	16	113.3	22.3	72.5	96.2		
53.5	17	102.5	23.7	66.0	88.1		
50.4	18	93.3	25.1	60.2	81.0		
47.0	19	85.3	26.5	55.2	74.8		
43.5	20	78.3	27.8	50.7	69.4		
35.4	22	66.4	30.6	43.1	60.2		

7. Superlift heavy boom working condition (SHB)

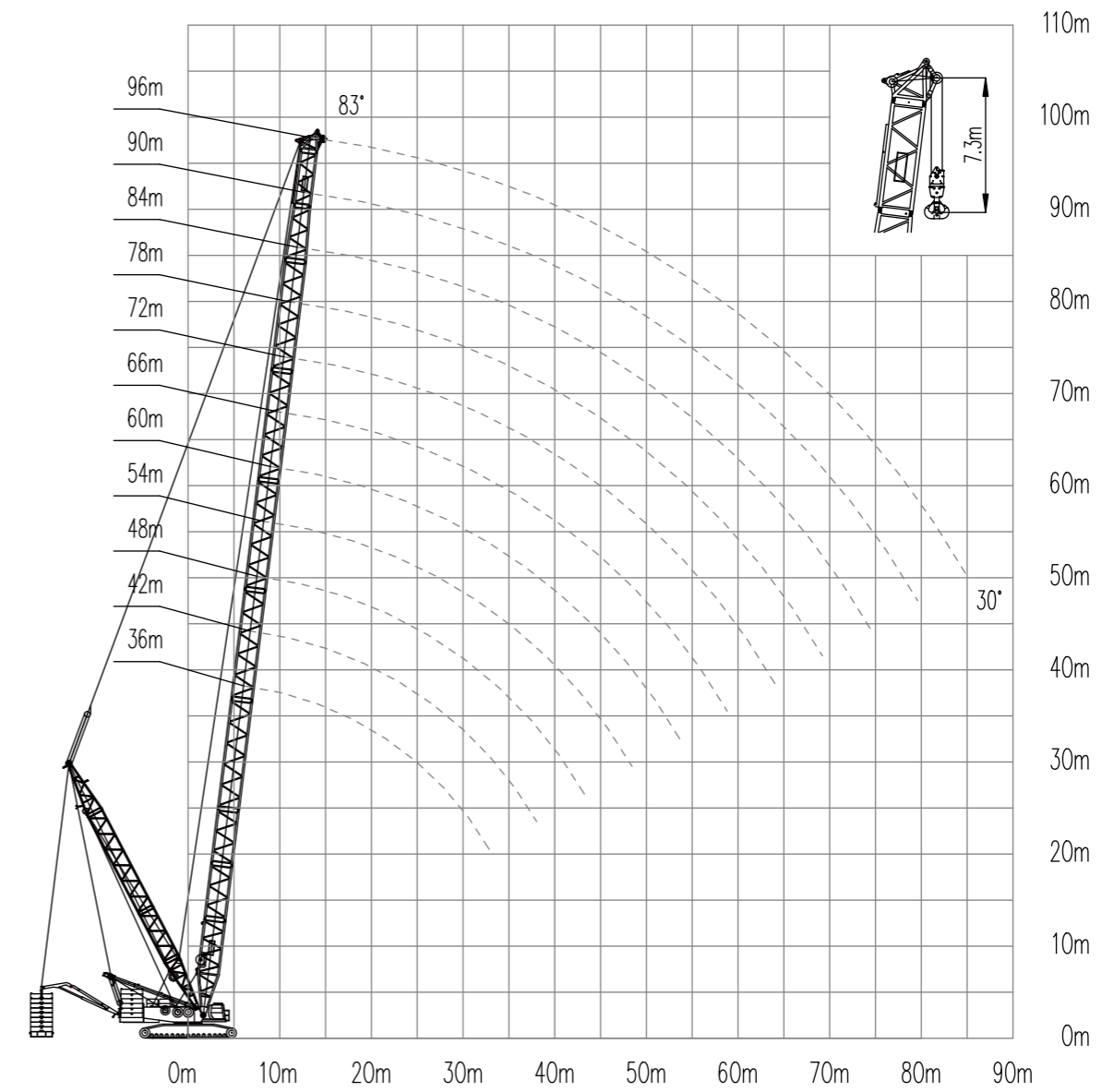

LIFTING CAPACITY TABLE IN TYPICAL WORKING CONDITIONS

Turntable counterweight		110t		Car-body counterweight		40t					
Superlift mast radius		13m		Superlift counterweight radius		16m					
Superlift counterweight		230t									
Radius (m)	Boom length (m)										
	36	42	48	54	60	66	72	78	84	(90)	(96)
8	400*										
9	400*	400*	400*								
10	400*	400*	392*	352*							
12	384*	392*	384*	352*	326*	281*	242*				
14	367	372	372	338*	326*	281*	242*	203*	174.4*	150.9*	
16	317	322	321	324	314	281*	242*	203*	174.4*	150.9*	131.5*
18	279	286	286	285	284	272	242*	203*	174.4*	150.9*	131.5*
20	256	255	254	254	253	253	242	203*	174.4*	150.9*	131.5*
22	228	230	229	229	228	227	236	203	174.4*	150.9*	131.5*
24	204	208	208	208	207	206	214	203	174.4	150.9*	131.5*
26	184.5	195.9	191	190.3	189.5	196.9	196	195.5	174.4	150.9*	131.5*
28	167.1	178	176	182.5	181.6	181.2	180.3	179.7	173.7	150.3	130.8*
30	151.9	162.5	169.6	168.9	168	167.6	166.7	166.2	165.2	149.3	129.9*
32	138.2	148.8	157.1	157.1	156.2	155.8	154.9	154.3	153.3	148.2	128.9
34		136.6	144.6	146.6	145.7	145.3	144.4	143.9	142.9	142	128
36		125.5	133.5	137.3	136.5	136	135.2	134.6	133.6	132.8	127
38		115.3	123.5	129	128.2	127.8	126.9	126.3	125.4	124.5	123.5
40			114.4	119.9	120.6	120.3	119.4	118.9	117.9	117.1	116.1
42			105.9	111.6	113.3	113	112.2	111.8	110.9	110.1	109.3
44			104	106.7	106.4	105.6	105.2	104.3	103.5	102.7	
46				96.9	100.7	100.4	99.7	99.2	98.4	97.6	96.7
48				90.3	95.1	95	94.2	93.7	92.9	92.1	91.2
50					89.1	90	89.2	88.8	87.9	87.2	86.3
54					78	81.2	80.5	80	79.2	78.4	77.5
58						72.5	73	72.5	71.7	70.9	70
62							66.5	66.1	65.2	64.5	63.6
66								60.4	59.6	58.8	57.9
70									54.6	53.8	53
74									50.2	49.4	48.5
78										45.5	44.6
82											41

8. Superlift light boom working condition (SLB)

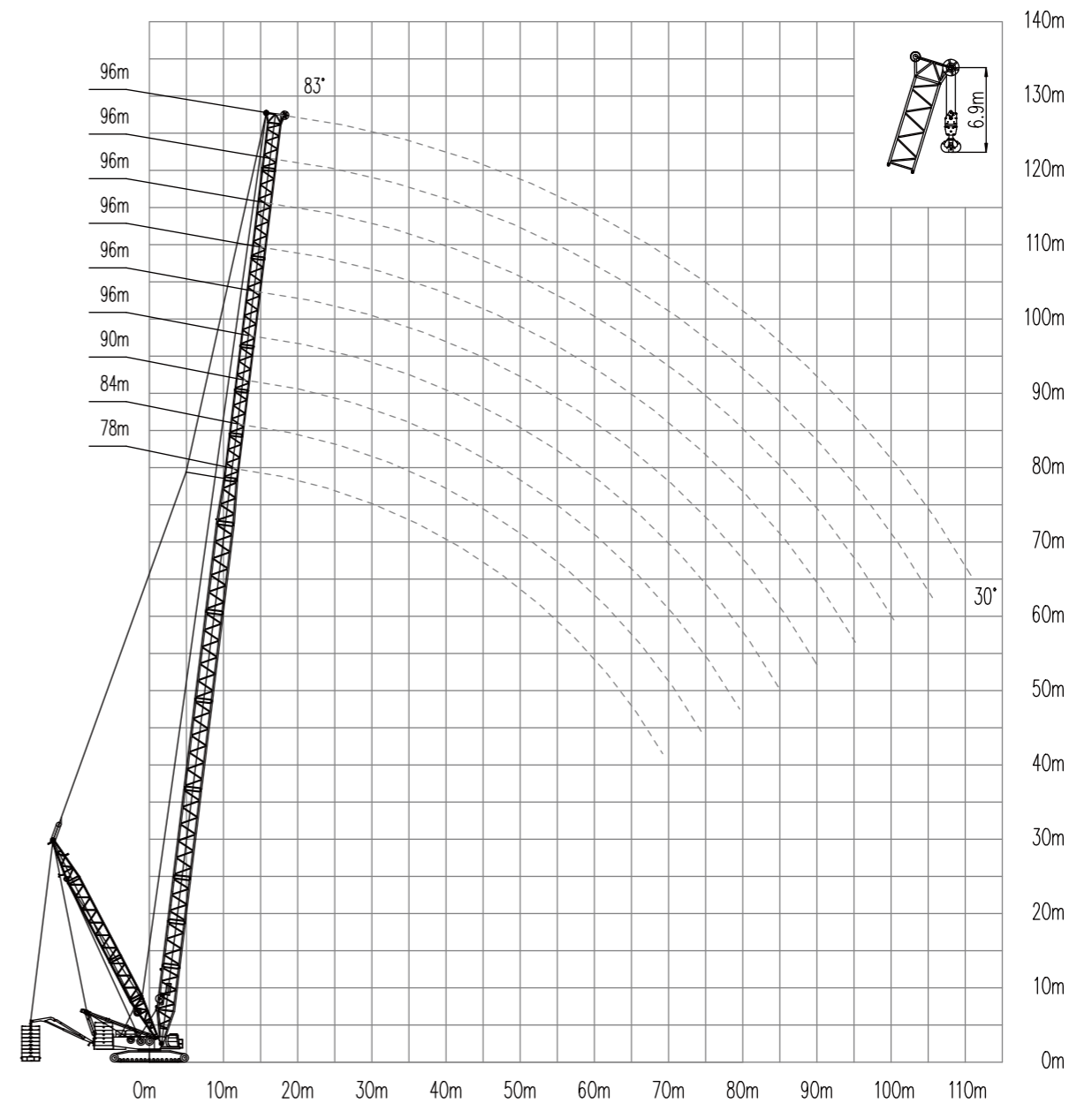

LIFTING CAPACITY TABLE IN TYPICAL WORKING CONDITIONS

Turntable counterweight	110t		Car-body counterweight		40t						
Superlift mast radius	13m		Superlift counterweight radius		16m						
Superlift counterweight	230t										
Radius (m)	Boom length (m)										
	72	78	84	90	96	102	108	114	120	126	
12	216*										
14	216*	193.3*	168.9*	142.4*							
16	216*	192.8*	168.7*	142.2*	125.6*	107.1*					
18	216*	192.1*	168.3*	138.8*	125.3*	106.7*	91.4*	78.1*	67.3*		
20	216*	191.2*	167.8*	135.4*	124.9*	106.3*	90.9*	77.6*	66.8*	57.8*	
22	216	190.2*	167.2*	132.3*	124.4*	105.8*	90.4*	77.1*	66.3*	57.3*	
24	214	189	166.4*	129.3*	123.8*	105.2*	89.9*	76.6*	65.8*	56.8*	
26	196.3	187.7	165.6	125.7*	123.2*	104.7*	88.6*	76*	65.2*	55.2*	
28	184.6	183.8	164.7	123.1*	122.6*	104.1*	86.4*	74.9*	62.9*	53.7*	
30	171	170.2	163.8	120*	121.9*	103.4*	84.2*	73.1*	61.2*	52.2*	
32	159.2	158.3	157.2	116.2*	120.8*	102.8*	82.2*	71.3*	60.3*	50.7*	
34	148.7	147.9	146.8	112.5*	118.6	101.7*	80.1*	69.5*	58*	49.3*	
36	139.5	138.7	137.5	109.1	115.8	99.9*	78.1*	68.8*	56.3*	48*	
38	131.2	130.4	129.3	105.8	113.6	97.9*	76.1*	66*	54.9*	46.7*	
40	123.7	122.9	121.8	102.8	111.5	95.6	74.1*	64.4*	53.4*	45.4*	
42	116.5	115.8	114.8	100	109.5	94.1	72.4*	62.8*	52*	44.2*	
44	109.9	109.2	108.2	97.4	107	92.2	70.7*	61.2*	50.7*	43*	
46	103.9	103.2	102.2	95	101	90.4	68.9*	59.8*	49.4*	41.9*	
48	98.5	97.8	96.8	92.8	95.6	88.7	67.4*	58.4*	48.2*	40.8*	
50	93.5	92.8	91.8	90.7	90.6	87	65.8*	56.9*	47*	39.8*	
54	84.8	84.1	83.1	82.7	81.9	81.8	63.1	54.5*	44.8*	37.9*	
58	77.3	76.6	75.6	75.3	74.4	74.3	60.4	52.2*	42.8*	36.2*	
62	70.8	70.1	69.1	68.8	68	67.9	57.8	50.1	41*	34.3*	
66		64.5	63.5	63.2	62.3	62.2	55.6	48.4	39.3*	32.7*	
70			58.5	58.2	57.4	57.3	53.7	46.6	37.6*	31.2*	
74			54.1	53.8	53	52.9	52.1	45.1	36.1*	29.8*	
78				49.9	49	48.9	48.5	43.7	34.9	28.7*	
82					45.5	45.4	45	42.6	33.8	27.6*	
86						42.2	41.8	41.7	32.8	26.7*	
90						39.3	38.9	38.8	32.1	25.9	
94							36	36.2	31.5	25.3	
98								33.8	31	24.7	
102									30.8	24.3	
106									28.8	24.1	
110										24	

9. Superlift tower jib working condition (SHW)

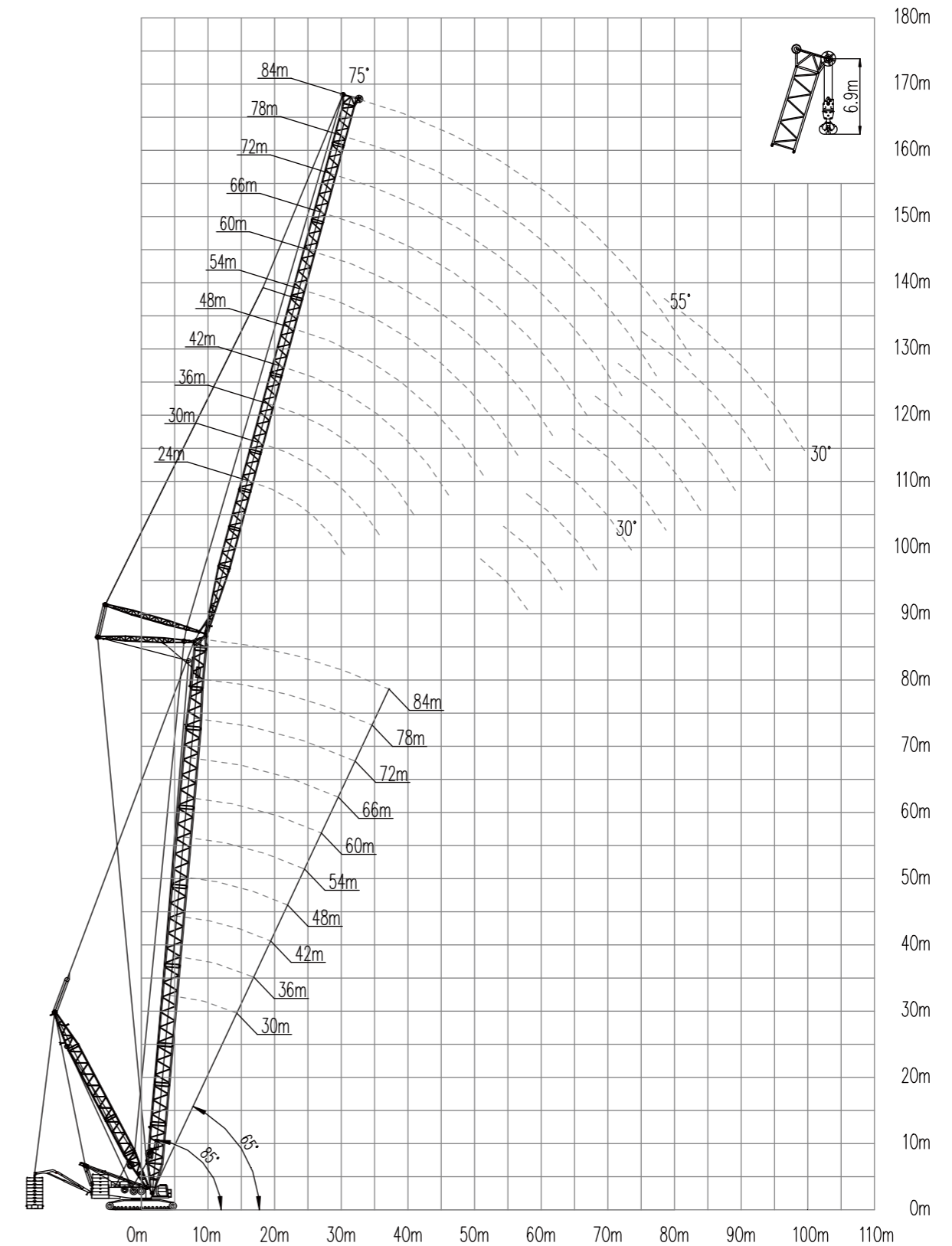

LIFTING CAPACITY TABLE IN TYPICAL WORKING CONDITIONS

Boom length 36m		Boom angle 85°											
Turntable counterweight 110t		Car-body counterweight 40t											
Superlift mast radius 13m		Superlift counterweight radius 16m					superlift counterweight 230t						
Radius (m)	Tower jib length (m)												
	24	30	36	42	48	54	60	66	72	78	84		
14	220												
16	220	187											
18	211.4	186.1	154.8	127.7									
20	182	173.2	151.2	127.3	104.4								
22	159.7	159.8	142.7	124.6	104	86.1							
24	142.2	143.1	133.6	118.7	103.5	85.7	73.3						
26	128	128.8	124.3	112.5	99.7	85.2	73	61.8	52.7				
28		117	115	106	95.3	84.2	72.7	61.5	52.4	44.9			
30		107.2	106.1	99.3	90.7	81.1	72.3	61.2	52	44.6	38.8		
32		98.8	97.5	92.8	85.9	77.8	70.1	60.8	51.7	44.3	38.5		
34			89.5	86.4	81.1	74.3	67.7	60.3	51.3	44	38.2		
36			82	80.3	76.4	70.8	65.1	58.5	50.9	43.6	37.9		
38				74.5	71.7	67.3	62.4	56.6	50.6	43.3	37.5		
40				69	67.2	63.8	59.7	54.6	49.2	42.9	37.2		
42				63.8	62.9	60.3	57	52.6	47.7	42.5	36.9		
44					58.7	56.9	54.3	50.6	46.2	41.6	36.6		
46					54.8	53.6	51.7	48.5	44.6	40.5	36.3		
48						50.5	49	46.4	43	39.3	35.5		
50							47.5	46.5	44.4	41.4	38	34.6	
54								41.6	40.4	38.2	35.6	32.7	
58									37.2	36.6	35.1	33.1	30.7
62										33	32.1	30.6	28.7
66											29.2	28.2	26.8
70												26	24.9
74													23
78													21.3

Boom length 42m		Boom angle 85°														
Turntable counterweight 110t		Car-body counterweight 40t														
Superlift mast radius 13m		Superlift counterweight radius 16m					superlift counterweight 230t									
Radius (m)	Tower jib length (m)															
	24	30	36	42	48	54	60	66	72	78	84					
14	210.8															
16	208.5	175.8														
18	191.1	168.8	145.6													
20	173.3	157.1	138.4	118.5	97.8											
22	156	144.8	130.4	115	97.7	81.3										
24	139.9	132.6	121.8	109.3	96.4	81.1	69.5									
26	125.1	120.8	113.1	103.3	92.4	80.7	69.3	58.9								
28		109.7	104.5	97	88.1	78.6	69.1	58.7	50.1	43.1						
30		99.4	96.3	90.7	83.5	75.4	67.8	58.5	49.9	42.9	37.3					
32		90	88.4	84.5	78.9	72.1	65.5	58.2	49.6	42.6	37.1					
34			81	78.5	74.2	68.7	63	56.6	49.3	42.3	36.8					
36				74.2	72.8	69.7	65.2	60.3	54.7	49	42.1	36.6				
38				67.8	67.4	65.2	61.7	57.7	52.8	47.6	41.8	36.3				
40					62.3	60.9	58.2	55	50.8	46.1	41.4	36				
42					57.5	56.9	54.9	52.3	48.7	44.5	40.3	35.7				
44						53	51.7	49.6	46.6	42.9	39.1	35.3				
46							49.4	48.5	47	44.5	41.3	37.8	34.3			
48								45.9	45.6	44.5	42.4	39.7	36.6	33.4		
50									42.7	42	40.4	38.1	35.3	32.4		
54										37.4	36.5	34.8	32.8	30.4		
58											33.2	32.8	31.7	30.2	28.3	
62												29.4	28.8	27.8	26.3	
66													26.1	25.4	24.3	
70														23.2	22.4	
74															21.1	20.6
78																18.9

LIFTING CAPACITY TABLE IN TYPICAL WORKING CONDITIONS

Boom length 48m		Boom angle 85°									
Turntable counterweight 110t		Car-body counterweight 40t									
Superlift mast radius 13m		Superlift counterweight radius 16m					superlift counterweight 230t				
Radius (m)	Tower jib length (m)										
	24	30	36	42	48	54	60	66	72	78	84
16	188.2	163									
18	173.4	153.8	133.7								
20	157.9	143.4	127.2	106.5							
22	142.8	132.5	119.9	106.4	91.5						
24	128.6	121.6	112	101.1	89.8	76.5	65.8				
26	115.4	111	104.1	95.5	86	76.3	65.7	56.1			
28	103.6	101	96.2	89.6	81.8	73.5	65.5	55.9	47.9		
30		91.7	88.6	83.8	77.5	70.4	63.6	55.7	47.8	41.2	35.9
32		83.2	81.5	78	73.1	67.2	61.3	55	47.5	41	35.7
34			74.7	72.4	68.7	63.9	58.8	53.3	47.3	40.7	35.5
36			68.5	67.1	64.4	60.5	56.3	51.4	46.3	40.5	35.3
38			62.7	62.1	60.2	57.2	53.7	49.4	44.8	40.2	35
40				57.4	56.2	53.9	51	47.4	43.3	39.2	34.8
42				53.1	52.4	50.7	48.4	45.4	41.8	38	34.3
44					48.8	47.6	45.9	43.3	40.2	36.8	33.4
46					45.4	44.7	43.4	41.3	38.6	35.5	32.4
48					42.2	41.9	41	39.3	36.9	34.3	31.4
50						39.3	38.6	37.3	35.3	33	30.4
54							34.4	34.3	33.6	32.2	30.4
58								30.3	30.1	29.2	27.9
62									26.9	26.4	25.5
66										23.8	23.3
70											21.1
74											19.1
78											17.1

Boom length 54m		Boom angle 85°									
Turntable counterweight 110t		Car-body counterweight 40t									
Superlift mast radius 13m		Superlift counterweight radius 16m					superlift counterweight 230t				
Radius (m)	Tower jib length (m)										
	24	30	36	42	48	54	60	66	72	78	84
16	168.8										
18	156	139.2	121.9								
20	142.6	130	116	101.7							
22	129.4	120.2	109.3	97.8	85.3						
24	116.9	110.5	102.2	92.8	83	72					
26	105.3	101	94.9	87.5	79.3	70.9	62.1	53.2			
28	94.8	92.1	87.8	82.1	75.3	68.2	61.3	53.1	45.7		
30		83.7	80.9	76.6	71.2	65.2	59.2	53	45.6	39.4	
32		76.1	74.3	71.3	67.1	62	56.9	51.4	45.4	39.3	34.3
34			68.2	66.1	62.9	58.8	54.5	49.6	44.7	39.1	34.1
36			62.5	61.3	58.9	55.6	52	47.8	43.3	38.9	33.9
38			57.3	56.7	55	52.4	49.4	45.8	41.8	37.8	33.7
40				52.4	51.3	49.3	46.9	43.8	40.3	36.7	33.1
42				48.4	47.7	46.3	44.4	41.8	38.8	35.5	32.2
44				44.7	44.4	43.4	42	39.8	37.2	34.3	31.3
46					41.3	40.7	39.6	37.9	35.6	33	30.3
48					38.4	38.1	37.3	35.9	34	31.7	29.3
50						35.7	35.1	34	32.4	30.5	28.3
54							31.2	31.1	30.5	29.4	27.9
58								27.4	27.2	26.5	25.5
62									24.2	23.8	23.2
66										21.4	21
70										19.2	19
74											17.1
78											15.2

LIFTING CAPACITY TABLE IN TYPICAL WORKING CONDITIONS

Boom length 60m		Boom angle 85°									
Turntable counterweight 110t		Car-body counterweight 40t									
Superlift mast radius 13m		Superlift counterweight radius 16m					superlift counterweight 230t				
Radius (m)	Tower jib length (m)										
	24	30	36	42	48	54	60	66	72	78	84
16	151.5										
18	140.7	126.1									
20	129.2	118	105.9	92							
22	117.8	109.5	99.9	89.8	79.3						
24	106.8	100.8	93.5	85.2	76.6	67.4					
26	96.6	92.4	86.9	80.4	73.2	65.8	58.4				
28	87.3	84.4	80.4	75.4	69.5	63.2	57.1	50.3	43.4		
30		77	74.2	70.4	65.6	60.3	55	49.6	43.3	37.6	
32		70.1	68.3	65.5	61.8	57.4	52.8	48	43.1	37.5	32.8
34		63.9	62.8	60.8	57.9	54.3	50.5	46.2	41.8	37.3	32.7
36			57.6	56.3	54.2	51.3	48.1	44.4	40.4	36.5	32.5
38			52.9	52.1	50.6	48.3	45.7	42.5	39	35.5	32
40				48.2	47.1	45.4	43.3	40.6	37.5	34.3	31.1
42				44.5	43.9	42.6	40.9	38.7	36	33.1	30.2
44				41.2	40.8	39.9	38.6	36.8	34.4	31.9	29.2
46					38	37.4	36.4	34.9	32.9	30.7	28.3
48					35.3	35	34.2	33	31.3	29.4	27.3
50					32.8	32.7	32.2	31.3	29.8	28.2	26.2
54						28.6	28.4	27.9	26.9	25.7	24.2
58							25	24.8	24.2	23.4	22.2
62								22.1	21.7	21.1	20.3
66									19.4	19.1	18.5
70									17.4	17.2	16.7
74										15.4	15.2
78											13.7

Boom length 66m		Boom angle 85°									
Turntable counterweight 110t		Car-body counterweight 40t									
Superlift mast radius 13m		Superlift counterweight radius 16m					superlift counterweight 230t				
Radius (m)	Tower jib length (m)										
	24	30	36	42	48	54	60	66	72	78	84
16	133.9										
18	125.4	112.3									
20	116.1	105.8	94.9								
22	106.6	98.7	89.9	81							
24	97.4	91.4	84.5	77.1	69.5	61.5					
26	88.7	84.3	78.9	72.9	66.5	59.9	53.5				
28	80.7	77.4	73.4	68.6	63.2	57.6	52.1	46.4			
30		71	68	64.3	59.9	55.1	50.3	45.4	40.3	35.1	
32		65	62.8	60	56.5	52.4	48.3	44	39.6	35	30.7
34		59.5	58	55.9	53.1	49.7	46.2	42.4	38.4	34.6	30.6
36			53.4	51.9	49.7	47	44	40.7	37.2	33.7	30.3
38			49.2	48.2	46.5	44.4	41.9	39	35.8	32.6	29.5
40			45.3	44.7	43.5	41.8	39.7	37.3	34.5	31.6	28.7
42				41.4	40.6	39.2	37.5	35.5	33	30.5	27.8
44				38.4	37.8	36.8	35.5	33.8	31.6	29.3	26.9
46					35.2	34.5	33.4	32	30.2	28.2	26
48					32.8	32.3	31.5	30.4	28.8	27	25.1
50					30.6	30.3	29.7	28.7	27.4	25.9	24.1
54						26.5	26.2	25.7	24.7	23.6	22.2
58							23.2	22.9	22.2	21.4	20.4
62								20.4	19.9	19.4	18.6
66								18.1	17.9	17.5	16.9
70									16	15.7	15.3
74										14.2	13.8
78											12.5

LIFTING CAPACITY TABLE IN TYPICAL WORKING CONDITIONS

Boom length 72m		Boom angle 85°									
Turntable counterweight 110t		Car-body counterweight 40t									
Superlift mast radius 13m		Superlift counterweight radius 16m					superlift counterweight 230t				
Radius (m)	Tower jib length (m)										
	24	30	36	42	48	54	60	66	72	78	84
18	113.6	102									
20	105.7	96.4	86.8								
22	97.5	90.2	82.4	74.4							
24	89.5	83.9	77.6	70.9	64.1						
26	81.9	77.6	72.6	67.2	61.4	55.5	50				
28	74.8	71.5	67.6	63.3	58.4	53.4	48.4	43.6			
30	68.3	65.7	62.8	59.3	55.3	51	46.7	42.3	38		
32		60.3	58.1	55.4	52.2	48.6	44.8	40.9	36.9	33.2	29.2
34		55.4	53.7	51.7	49.1	46.1	42.8	39.4	35.8	32.3	29
36			49.6	48.1	46	43.6	40.8	37.8	34.6	31.4	28.3
38			45.8	44.7	43.1	41.1	38.8	36.2	33.3	30.5	27.6
40			42.3	41.5	40.3	38.7	36.7	34.5	32	29.4	26.8
42				38.5	37.6	36.3	34.7	32.9	30.7	28.4	25.9
44				35.7	35.1	34.1	32.8	31.2	29.3	27.3	25.1
46					32.7	32	30.9	29.6	28	26.2	24.2
48					30.5	30	29.1	28.1	26.6	25	23.3
50					28.4	28.1	27.4	26.5	25.3	23.9	22.3
54						24.6	24.2	23.7	22.8	21.8	20.5
58							21.4	21.1	20.5	19.7	18.7
62								18.7	18.3	17.8	17
66								16.6	16.4	16	15.4
70									14.6	14.4	14
74										12.9	12.6
78											11.3
82											10.2

Boom length 78m		Boom angle 85°									
Turntable counterweight 110t		Car-body counterweight 40t									
Superlift mast radius 13m		Superlift counterweight radius 16m					superlift counterweight 230t				
Radius (m)	Tower jib length (m)										
	24	30	36	42	48	54	60	66	72	78	84
18	100.8										
20	94.6	86.1	77.2								
22	88	81.1	73.9	66.8							
24	81.4	75.9	70	63.9	57.8						
26	75	70.6	65.8	60.8	55.5	50.3					
28	69	65.4	61.6	57.5	53	48.4	43.9	39.6			
30	63.4	60.5	57.5	54.1	50.3	46.4	42.4	38.5	34.6		
32		55.9	53.5	50.7	47.6	44.2	40.7	37.2	33.7	30.3	
34		51.6	49.6	47.5	44.9	42.1	39	35.9	32.7	29.5	26.5
36		47.6	46.1	44.3	42.2	39.9	37.2	34.5	31.6	28.7	25.9
38			42.7	41.4	39.7	37.7	35.4	33.1	30.4	27.8	25.2
40			39.6	38.5	37.2	35.5	33.6	31.6	29.2	26.9	24.5
42				35.9	34.8	33.5	31.9	30.1	28	25.9	23.7
44				33.4	32.6	31.5	30.2	28.6	26.8	24.9	22.9
46				31.1	30.5	29.6	28.5	27.2	25.6	23.9	22.1
48					28.5	27.8	26.9	25.8	24.4	22.9	21.2
50					26.6	26.1	25.3	24.4	23.2	21.9	20.4
54						23	22.5	21.9	21	20	18.7
58							19.9	19.5	18.8	18.1	17.1
62							17.6	17.4	16.9	16.3	15.6
66								15.5	15.1	14.7	14.1
70									13.5	13.2	12.8
74										11.9	11.5
78											10.4
82											9.3

LIFTING CAPACITY TABLE IN TYPICAL WORKING CONDITIONS

Boom length 84m		Boom angle 85°									
Turntable counterweight 110t		Car-body counterweight 40t									
Superlift mast radius 13m		Superlift counterweight radius 16m					superlift counterweight 230t				
Radius (m)	Tower jib length (m)										
	24	30	36	42	48	54	60	66	72	78	84
18	91.5										
20	86.3	78.6									
22	80.7	74.3	67.8								
24	74.9	69.8	64.3	58.8	53.3						
26	69.4	65.2	60.7	56	51.2	46.5					
28	64.1	60.6	56.9	53.1	48.9	44.8	40.6				
30	59.1	56.2	53.2	50.1	46.5	42.9	39.3	35.7	32.1		
32		52.1	49.7	47	44.1	41	37.7	34.5	31.3	28.2	
34		48.2	46.2	44.1	41.6	39	36.1	33.3	30.3	27.5	24.6
36		44.7	43	41.3	39.2	37	34.5	32	29.3	26.7	24
38			39.9	38.5	36.9	35	32.8	30.7	28.2	25.8	23.4
40			37.1	36	34.6	33	31.2	29.3	27.1	24.9	22.7
42				33.6	32.4	31.1	29.6	27.9	26	24	22
44				31.3	30.4	29.3	28	26.6	24.8	23.1	21.2
46				29.2	28.5	27.6	26.4	25.2	23.7	22.1	20.4
48					26.6	25.9	24.9	23.9	22.6	21.2	19.6
50					24.9	24.3	23.5	22.6	21.5	20.3	18.9
54						21.5	20.9	20.3	19.4	18.4	17.3
58							18.5	18.1	17.4	16.7	15.8
62							16.4	16.1	15.6	15	14.3
66								14.4	14	13.5	12.9
70									12.5	12.2	11.7
74										10.9	10.5
78										9.8	9.4
82											8.5

10. Superlift goose head jib working condition (SHJ)

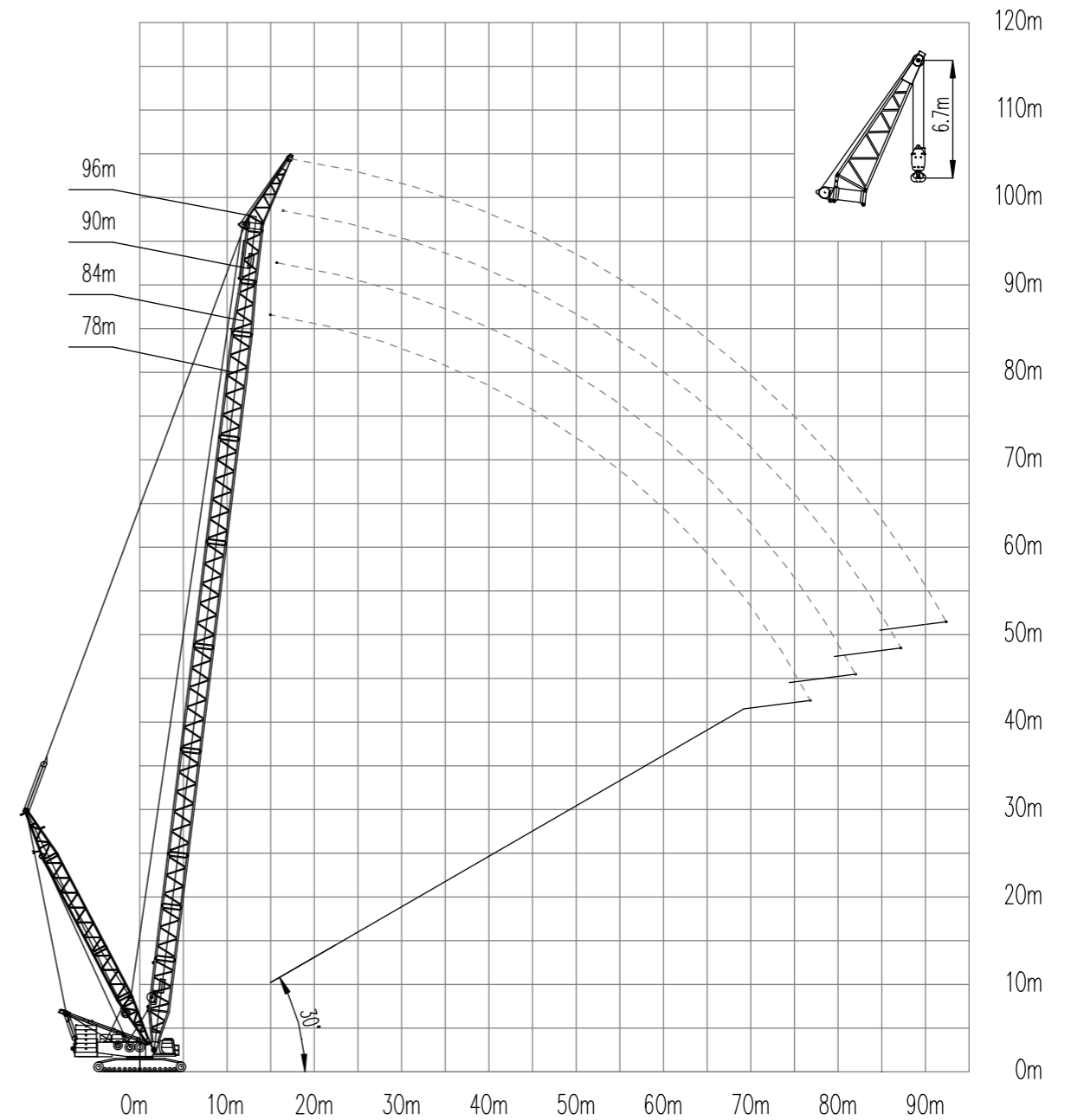

LIFTING CAPACITY TABLE IN TYPICAL WORKING CONDITIONS

Turntable counterweight 150t+Car-body counterweight 40t,
superlift mast radius 15m, superlift counterweight 0t

Radius (m)	Boom length (m)			
	78	84	90	96
16	116.6	108.8	103.4	93.9
17	109.5	104.5	102.6	92.9
18	103.5	100.5	97.3	91.7
20	91.7	89.5	87.3	84.3
22	81.9	80.0	78.0	76.0
24	73.6	72.0	70.2	68.3
26	65.9	65.0	63.5	61.8
28	59.4	58.6	57.5	56.0
30	53.9	53.1	52.2	50.9
32	49.0	48.2	47.3	46.4
34	44.6	44.0	43.2	42.3
36	40.8	40.2	39.4	38.6
38	37.4	36.7	36.0	35.2
40	34.4	33.7	33.0	32.1
42	31.7	31.1	30.3	29.5
44	29.2	28.6	27.8	27.0
46	27.0	26.4	25.6	24.8
48	25.0	24.4	23.6	22.7
50	23.2	22.5	21.7	20.9
54	19.9	19.2	18.4	17.5
58	17.1	16.4	15.6	14.7
62	14.7	14.0	13.2	12.3
66	12.5	11.9	11.1	10.2
70	10.6	10.0	9.2	8.3
74	9.0	8.3	7.5	6.6
78		6.8	6.0	

11. Superlift TBM working condition (SHFS)

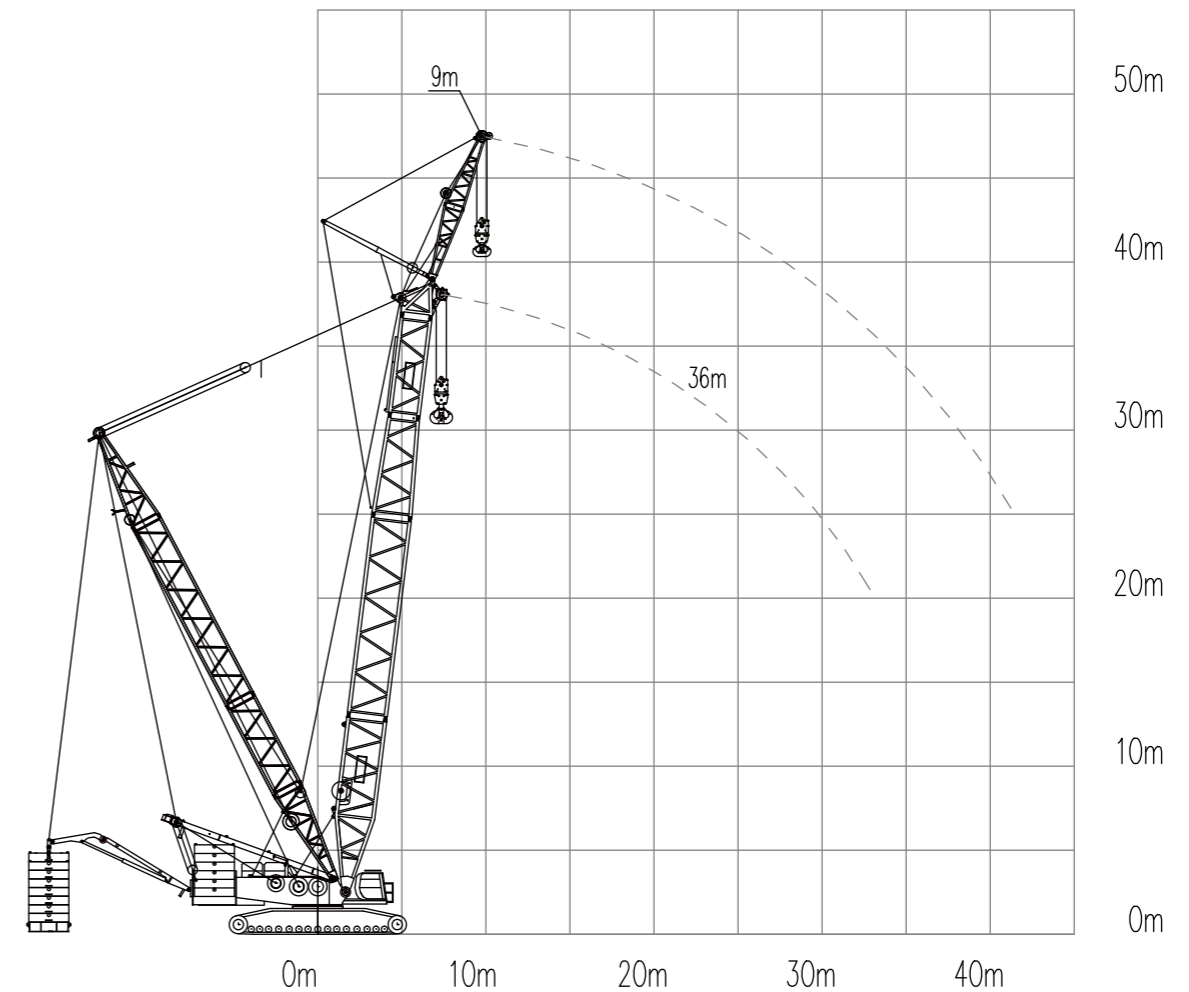

LIFTING CAPACITY TABLE IN TYPICAL WORKING CONDITIONS

Boom length 36m	Jib length 9m	Jib angle 10°
Turntable counterweight 110t	Car-body counterweight 40t	
Superlift mast radius 13m	Superlift counterweight radius 16m	superlift counterweight 230t

Boom angle	Main hook radius	Main hook load	Aux. hook radius	Aux. hook load	Total load of main and aux. hooks
°	(m)	(t)	(m)	(t)	(t)
82.0	8	400.0	10.5	185.0	364.0
80.4	9	400.0	11.8	185.0	356.9
78.7	10	400.0	13.1	185.0	350.1
77.1	11	400.0	14.3	185.0	343.8
75.5	12	400.0	15.6	185.0	337.9
73.8	13	400.0	16.8	185.0	332.3
72.1	14	388.6	18.1	185.0	327.1
70.4	15	359.6	19.4	185.0	314.1
68.7	16	334.5	20.6	182.9	292.5
66.9	17	312.2	21.9	175.1	273.3
65.2	18	291.9	23.1	168.1	256.2
63.4	19	273.7	24.4	161.6	240.7
61.5	20	257.2	25.6	155.6	226.7
57.8	22	228.5	28.2	145.0	201.3
53.8	24	204.1	30.7	135.9	180.0
49.6	26	182.7	33.2	128.1	161.9
45.1	28	164.2	35.6	121.3	146.2
40.2	30	148.0	38.1	113.7	132.4
34.7	32	133.4	40.6	102.7	120.0

46

XGC90 CRAWLER CRANE

P47-P56 TRANSPORT PLAN

P57-P57 SUPPLIED TOOLS

P58-P58 SUPPLIED SPARE PARTS

P59-P59 PACKING LIST

TRANSPORT PLAN

Table 1 Transport weight and dimensions for crane main parts (standard working condition)

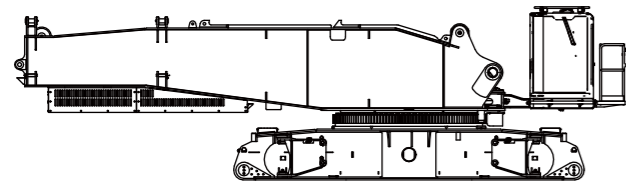

Basic machine × 1	
L	12.03 m
W	3.00 m
H	3.41 m
W	47.9 t

Include turntable, car-body (with 4 outrigger pads), cab and etc.

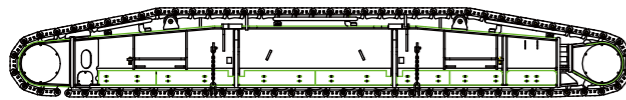

Left track frame × 1	
L	10.71 m
W	1.62 m
H	1.54 m
W	30.9 t

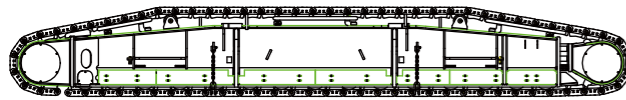

Right track frame × 1	
L	10.71 m
W	1.62 m
H	1.54 m
W	30.9 t



Mast assy × 1	
L	11.14 m
W	2.21 m
H	1.14 m
W	9.8 t

Include mast, main luffing pulley block, main luffing system and wire rope.

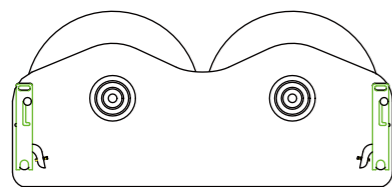

Hoist winch × 1	
L	2.41 m
W	1.90 m
H	1.13 m
W	9.56 t

Include main/aux. hoist rope

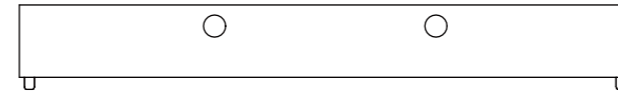

Central counterweight × 2	
L	6.08 m
W	1.64 m
H	0.84 m
W	20 t

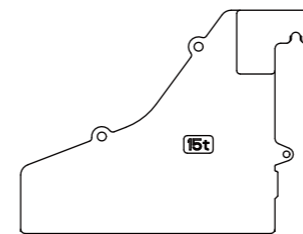

Turntable counterweight frame × 2	
L	2.62 m
W	2.68 m
H	2.03 m
W	15 t

Include counterweight locking chain assy.

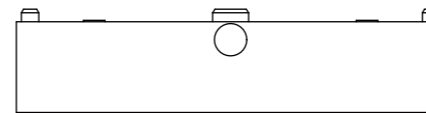

Counterweight slab × 12	
L	2.38 m
W	2.10 m
H	0.58 m
W	10 t

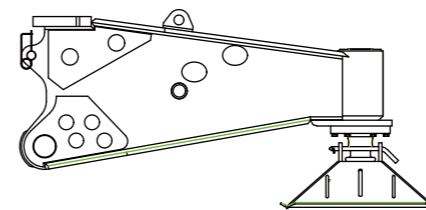

Outrigger × 2	
L	2.53 m
W	0.98 m
H	1.20 m
W	2.49 t

Include outrigger pads

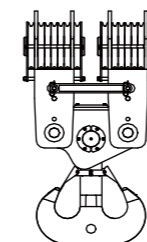

400t capacity hook block × 1	
L	1.68 m
W	0.95 m
H	3.10 m
W	6.65 t

TRANSPORT PLAN

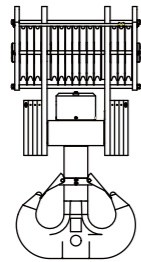

350t capacity hook block	× 1
L	1.44 m
W	0.87 m
H	2.82 m
W	6.16 t

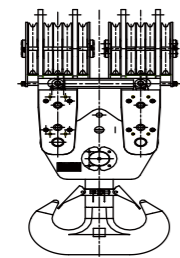

320t capacity hook block	× 1
L	1.31 m
W	1.22 m
H	2.97 m
W	6.0 t

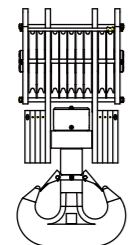

260t capacity hook block	× 1
L	1.02 m
W	0.87 m
H	2.34 m
W	3.94 t

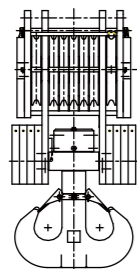

200t capacity hook block	× 1
L	0.95 m
W	0.99 m
H	2.25 m
W	4.20 t

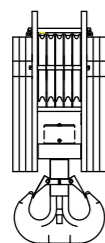

160t capacity hook block	× 1
L	0.87 m
W	0.76 m
H	2.13 m
W	3.91 t

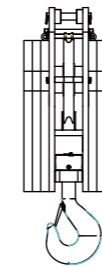

50t capacity hook block	× 1
L	0.64 m
W	0.76 m
H	1.84 m
W	2.43 t

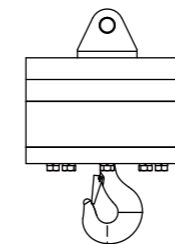

16t capacity hook block	× 1
L	0.60 m
W	0.60 m
H	0.87 m
W	0.88 t

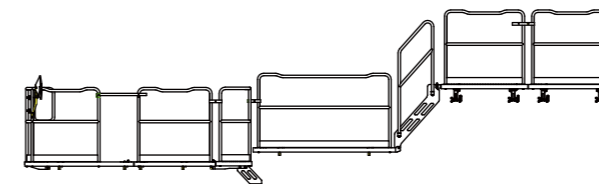

Catwalk	× 1
L	– m
W	– m
H	– m
W	0.48 t

Transport after disassembly

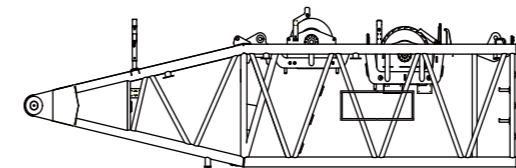

Boom butt	× 1
L	11.1 m
W	3 m
H	2.86 m
W	13.34 t

Include boom backstop cylinder, tower jib luffing winch and rope, some pendant

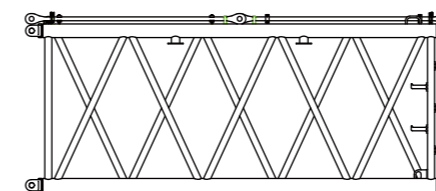

6m heavy boom insert	× 2
L	6.18 m
W	3 m
H	2.55 m
W	3.25 t

Include pendant

TRANSPORT PLAN

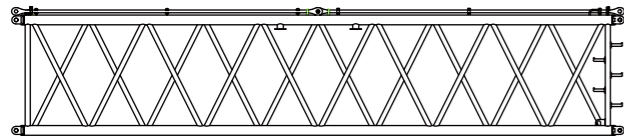

12m heavy boom insert I	× 1
L	12.18 m
W	3 m
H	2.55 m
W	5.79 t

Include pendant

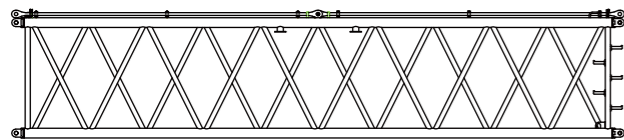

12m heavy boom insert II	× 1
L	12.18 m
W	3 m
H	2.55 m
W	5.82 t

Include pendant

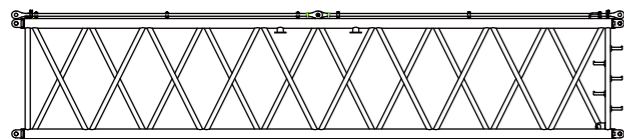

12m light boom insert	× 2
L	12.18 m
W	3 m
H	2.55 m
W	5.27 t

Include pendant

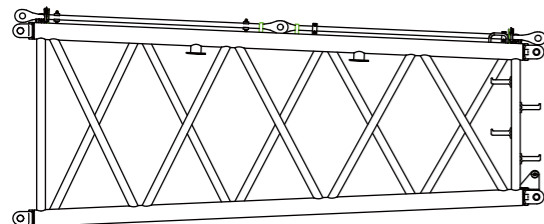

6m boom transition section	× 1
L	6.18 m
W	3 m
H	2.56 m
W	2.62 t

Include pendant

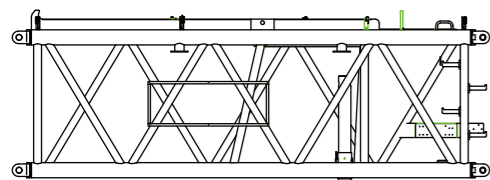

6m light boom insert	× 1
L	6.18 m
W	2.5 m
H	2.2 m
W	3.50 t

Include pendant and tower jib luffing pulley block

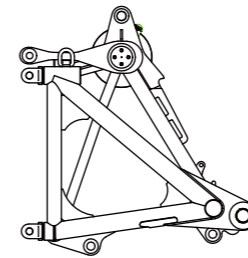

Boom head	× 1
L	2.57 m
W	2.59 m
H	2.72 m
W	3.62 t

Include pendant

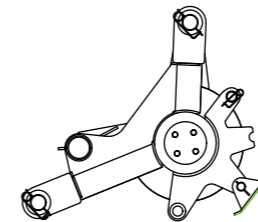

Boom sheave block	× 1
L	1.39 m
W	1.67 m
H	1.2 m
W	1.57 t

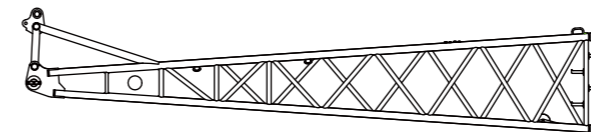

Tower jib butt	× 1
L	10.81 m
W	2.53 m
H	2.31 m
W	3.25 t

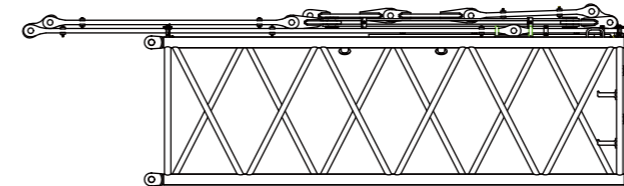

6m tower jib insert A	× 1
L	7.68 m
W	2.44 m
H	2.25 m
W	3.05 t

Include pendant balance beam

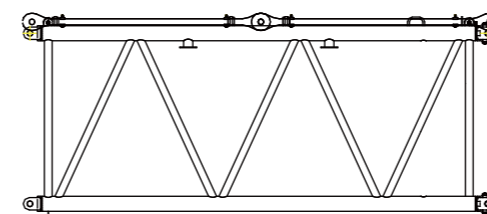

6m tower jib insert B	× 2
L	6.16 m
W	2.44 m
H	2.01 m
W	1.75 t

Include pendant

TRANSPORT PLAN

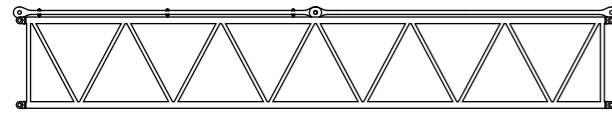

12m tower jib insert A	× 1
L	12.16 m
W	2.44 m
H	2.01 m
W	3.13 t

Include pendant

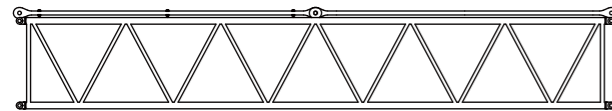

12m tower jib insert B	× 1
L	12.16 m
W	2.44 m
H	2.01 m
W	2.97 t

Include pendant

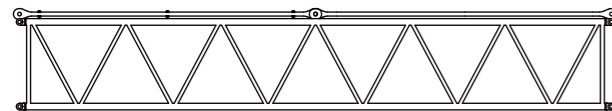

12m tower jib center hitch section	× 1
L	12.16 m
W	2.44 m
H	2.01 m
W	3.14 t

Include pendant

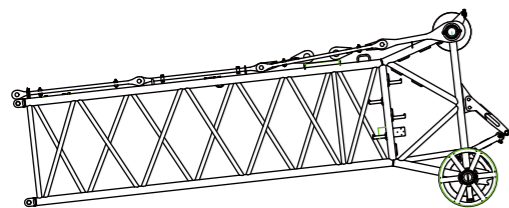

Tower jib top	× 1
L	8.51 m
W	2.44 m
H	3.35 m
W	4.46 t

Include pendant

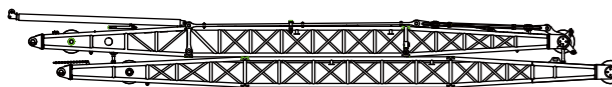

Tower jib top	× 1
L	16.25 m
W	2.61 m
H	2.06 m
W	8.73 t

Include pendant

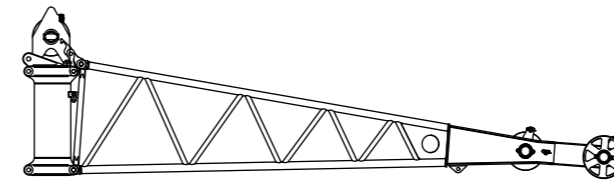

Goose head jib	× 1
L	10.05 m
W	2.44 m
H	2.91 m
W	3.8 t

Optional

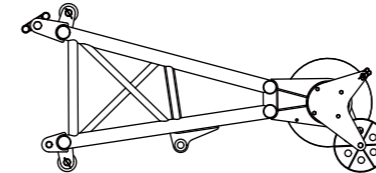

Single top	× 1
L	2.67 m
W	1.53 m
H	1.25 m
W	0.51 t

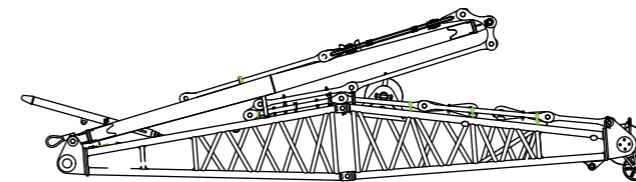

Fixed jib	× 1
L	10.12 m
W	3 m
H	2.78 m
W	5.36 t

Include fixed jib top, strut, front/rear pendants, backstop rod and etc., optional configuration

TRANSPORT PLAN

Table 2 Transport weight and dimensions for crane main parts (standard working condition)

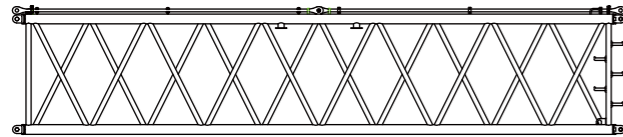

12m heavy boom insert I		× 1
L	12.18 m	
W	3 m	
H	2.55 m	
W	5.79 t	

Optional, include pendant

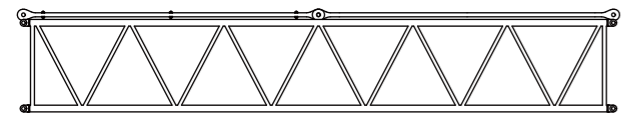

12m tower jib insert B		× 1
L	12.16 m	
W	2.44 m	
H	2.01 m	
W	2.97 t	

Include pendant

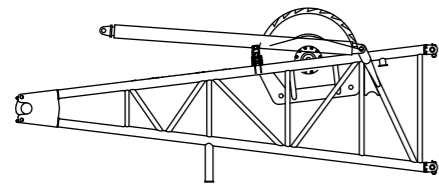

Superlift mast butt		× 1
L	6.24 m	
W	2.72 m	
H	2.00 m	
W	7.99 t	

Include superlift luffing winch and wire rope, superlift backstop cylinder and etc.

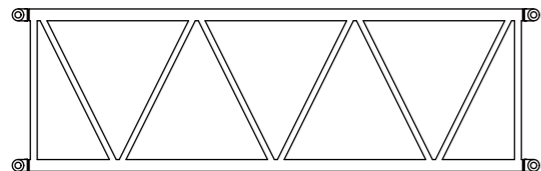

6m superlift mast insert		× 1
L	6.25 m	
W	2.49 m	
H	2.10 m	
W	1.60 t	

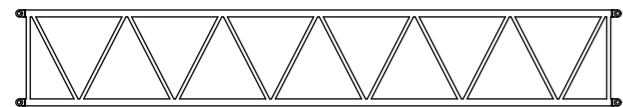

12m superlift mast insert		× 1
L	12.26 m	
W	2.49 m	
H	2.10 m	
W	2.66 t	

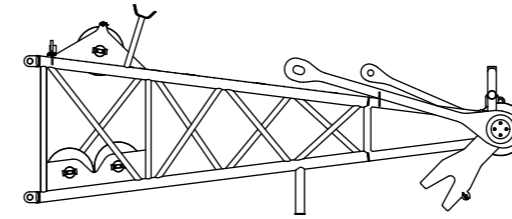

Superlift mast top		× 1
L	6.38 m	
W	2.44 m	
H	2.60 m	
W	3.52 t	

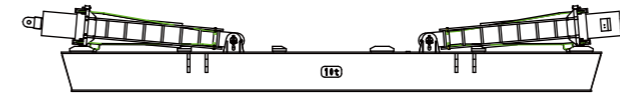

Superlift counterweight tray		× 1
L	9.15 m	
W	2.61 m	
H	1.27 m	
W	10 t	

Include superlift counterweight lifting cylinder

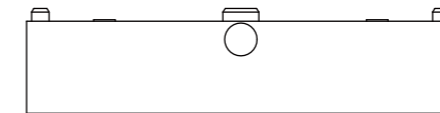

Counterweight slab		× 18
L	2.38 m	
W	2.10 m	
H	0.58 m	
W	10 t	

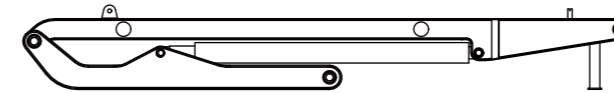

Superlift counterweight pushing cylinder		× 1
L	6.13 m	
W	3.20 m	
H	0.88 m	
W	3.46 t	

Include pushing cylinder

SUPPLIED TOOLS

No.	Code	Name	Qty.	Remark
1	174001024	WCW10-3000 Wire rope	2	
2	819942294	S-DX25-1 3/4 Shackle	2	
3	819954753	Tool kit (Xuzhou Hongjian)	1	
4	859932653	S-BW12-1 1/4 Shackle	4	
5	801500806	CQJ-16 Inflation tool	1	
6	175002541	WBW10-58000 Wire rope	1	
7	170000006	TU88001 Power trolley	1	
8	819900607	Lever type information bag	1	
9	819900454	AK-120 First-aid kit Domestic	1	
10	819948519	ORC-III Aluminum alloy ladder	1	
11	819910776	T-DX2-3/8 Shackle	4	
12	801970835	Dry powder fire extinguisher -6Kg	1	
13	803700631	S-BW2-1/2 Shackle	2	
14	859985208	ZS0202 ϕ 32 x 6.99M Wire rope	2	Used to lift crawler tracks
15	859985209	ZS0202 ϕ 32 x 6.85M Wire rope	2	Used to lift crawler tracks
16	840700012	Flat tape 10T x 8M (with buckles ay both ends)	2	Used to lift boom sections

SUPPLIED SPARE PARTS

No.	Code	Name	Qty.	Remark
1	803161924	JX-800 x 80 oil suction filter element	2	
2	803079383	YLXA-152 oil return filter element (Dongfeng Cummins)	2	
3	803161819	QXF-5 inflation check valve	2	
4	174002875	XGC400K.99.1 O-ring seal bag	1	
5	174002876	XGC400K.99.2 ED seal bag	1	
6	174002877	XGC400K.99.3 flange seal bag	1	
7	803400188	41390-4 hand-pressed grease filler (Nanjing Bijur)	1	
8	803678214	DT04-2P 2-core plug	10	
9	803678215	DT06-2S 2-core socket	10	
10	803678226	W2P locking plate of 2-core plug	10	
11	803678227	W2S locking plate of 2-core socket	10	
12	803678218	DT04-4P 4-core plug	5	
13	803678219	DT06-4S 4-core socket	5	
14	803678230	W4P locking plate of 4-core plug	5	
15	803678231	W4S locking plate of 4-core socket	5	
16	803678238	1060-16-0122 male pin	40	
17	803678239	1062-16-0122 female pin	40	
18	803602581	H2.5/14D tubular terminal	100	
19	803602274	H1/14 tubular terminal	100	
20	803689941	1616-21-10A Fuse	1	
21	803689942	1616-21-15A Fuse	7	
22	803689693	1616-21-20A Fuse	5	
23	803689943	1616-21-25A Fuse	1	
24	803700641	30A MIDI FUSE	1	
25	803700642	40A MIDI FUSE	1	
26	803700643	50A MIDI FUSE	1	
27	803611413	HFV4/0241Z4SGD2 relay	5	
28	800141108	Engine oil filter element	1	
29	800141109	Fuel filter element	1	
30	800141110	Oil-water separator filter element	2	
31	800104060	NLG37-32(C 30 1330) Air filter element	1	
32	170000003	Clip 5-50	8	
33	170000004	Clip 5-70	4	
34	170000029	Pin shaft ϕ 75 x 65	1	

PACKING LIST

Memorandum

No.	Name	Qty.	Package Remark	Remark
1	XGC400-I Crawler crane	1	Nude packing	Refill 20L oil to fuel tank
2	XGC400-I Product Certificate	1		
3	XGC400-I Crawler Crane Operation Manual	1		Include Lifting Capacity Manual
4	XGC400-I Crawler Crane Parts Catalogue	1		
5	XGC400-I Crawler Crane Maintenance Manual	1		
6	Engine Operation Instructions (X12 Cummins)	1		
7	Load Moment Limiter Operation Instructions	1		
8	Air Conditioner Operation Instructions	1		
9	Tools List	1		
10	Supplied Tools	1		
11	Spare Parts List	1		
12	Supplied Spare Parts	1		
13	Software and CD	1		
